

Rainin BenchSmart 96

High-throughput Pipetting System



Figure 1 BenchSmart 96 components

1. Liquid head
2. Head cover plate (clear)
3. Lateral rail
4. Tablet on arm
5. 2-position plate holder (2)
6. Adjustable feet (4)
7. Tip basket
8. Pipette head
9. Vertical head position control
10. Top cover
11. Front panel display and controls
12. Tip spacer block

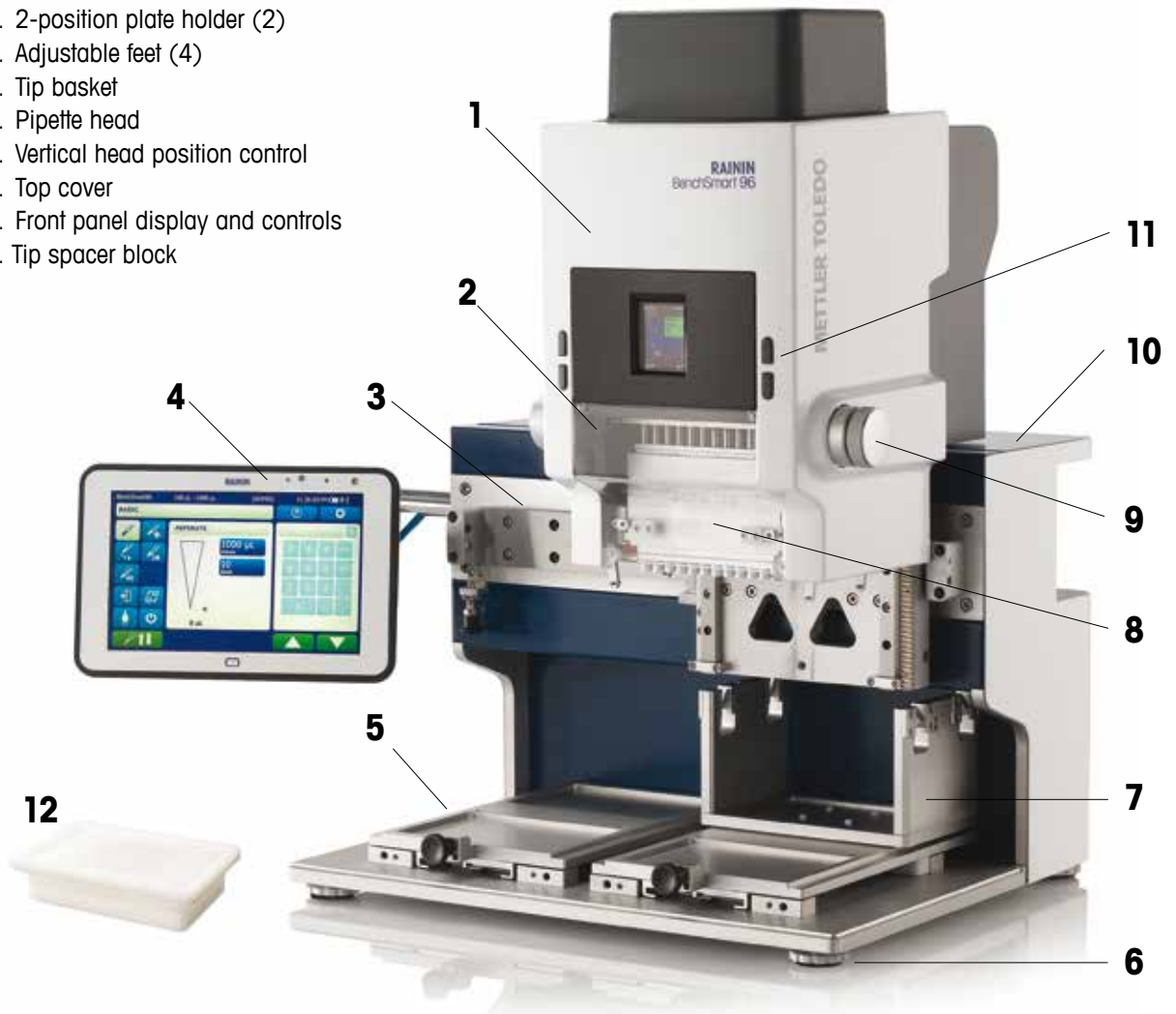

For product assistance contact Rainin in the U.S. or your local METTLER TOLEDO office. U.S. call: 800 4 RAININ (800 472-4646) or email techsupport@rainin.com. Outside the U.S. go to www.mt.com/rainin and use the Contact button in the navigation bar.

Have the following information available for the technical representative:

- Product serial number
- Software version (see About in the main Help menu)
- Any error number shown on the LCD display, the tablet, or in the log file.

Changes or modifications to this equipment not expressly approved by the party responsible for compliance could void the user's authority to operate the equipment.

© Copyright 2016 Mettler-Toledo Rainin, LLC. All rights reserved. Reproduction of any part of this manual by any means or in any form is prohibited without prior written consent of Mettler-Toledo Rainin, LLC. The information in this manual is subject to change without notice. Modifications to the product described in this manual may also be made at any time.

Rainin, LTS, BenchSmart are trademarks of Mettler-Toledo Rainin, LLC. in the United States and/or other countries. All other trademarks and registered trademarks are the property of their respective holders.

Table of Contents

1 Safety, Introduction and Set Up

1.1	Safety	7
1.2	Product specific safety precautions	7
1.3	Introduction	9
1.4	Unpacking and set up	9
1.4.1	Check the shipping crate	9
1.4.2	Unpacking the shipping crate	10
1.4.3	Set up, location and placement	10
1.4.4	Assembling and installing the tablet arm	11
1.4.5	Power up the BenchSmart and the tablet	13
1.4.6	Set preferred language	14
1.4.7	Installing the pipette head	15
1.5	Initial operational set up	17
1.5.1	Assigning new users and passwords	17
1.5.2	Setting date and time	19
1.5.3	Mode access	19
1.5.4	Setting instrument buttons	20
1.5.5	Tip Load sensor and Tip Load mode	21

2 Basic Operation

2.1	Loading tips	22
2.2	Aspirating and dispensing	24
2.2.1	Setting volume	24
2.2.2	Preparation for aspiration	25
2.2.3	Aspiration	25
2.2.4	Dispensing	25
2.2.5	Ejecting tips	26
2.3	Using the 384-well plate adapter	27

3 Advanced Operation

3.1	Advanced mode	28
3.1.1	Fixed volume	29
3.1.2	Volume sequencing	30
3.1.3	Mixing	31
3.1.4	Cycle count	32
3.1.5	Blowout	33
3.1.6	Mode presets	33
3.2	Multidispense mode	34
3.2.1	Fixed volume	35
3.2.2	Volume sequencing	37
3.2.3	Autopace	39
3.2.4	Blowout	39
3.2.5	Mode presets	39
3.3	Dilute mode	39
3.3.1	Volume sequencing	40
3.3.2	Mix	41
3.3.3	Blowout	41
3.3.4	Mode presets	42
3.4	Reverse mode	42
3.4.1	Fixed volume	42

3.4.2	Volume sequencing	44
3.4.3	Cycle count	44
3.4.4	Blowout	45
4	Care and use	
4.1	Cleaning	46
4.1.1	Tablet and instrument screens, plastic cover	46
4.1.2	Outer surfaces	46
4.1.3	Plate trays	46
4.1.4	Lateral rail	46
4.2	Maintenance	46
4.2.1	Routine check	46
4.2.2	Pipette head lateral movement	47
4.2.3	Pipette head vertical movement	47
4.2.4	Plate tray forward and back movement	47
4.3	Troubleshooting	48
5	Specifications	
5.1	Performance specifications	50
5.2	Electrical specifications	50
5.3	Electrical considerations	50
5.4	Power cord	50
5.5	Power malfunction	50
6	Ordering	
6.1	Ordering information	51
A	Appendices	
A.1	Transport lock	52
A.2	Liquid head left and right stops	52
A.3	Rear and front tray stops	54
A.4	Rear and front tray stops using 384-well plates	56
A.5	Service operations	59
EC Declaration of Conformity	Inside back cover

Figures

1 Safety, Introduction and Set Up

Figure 1	BenchSmart 96 components	Inside front cover
Figure 1-1	Contents of shipping crate	10
Figure 1-2	Removing the shipping bracket	10
Figure 1-3	Tablet arm components	11
Figure 1-4	Fixed mounting screw	11
Figure 1-5	Partial assembly	11
Figure 1-6	Tablet arm installed	12
Figure 1-7	Cable plug	12
Figure 1-8	Arm and tablet mounting plates	12
Figure 1-9	Power switch	13
Figure 1-10	Front panel display at power up	13
Figure 1-11	Tablet controls	14
Figure 1-12	User Login screen	14
Figure 1-13	Initialization screen	14
Figure 1-14	Head load screen	14
Figure 1-15	Head change screen	14
Figure 1-16	Home screen	14

Figure 1-17	Main setup screen.....	14
Figure 1-18	Select language	15
Figure 1-19	Setup screen in local language.....	15
Figure 1-20	Pipette head components	15
Figure 1-21	Using an empty rack to support the pipette head.....	15
Figure 1-22	Head load sequence	16
Figure 1-23	Home screen	17
Figure 1-24	User settings.....	17
Figure 1-25	Admin settings for new user setup	17
Figure 1-26	Add user	18
Figure 1-27	Add user name	18
Figure 1-28	Name displayed.....	18
Figure 1-29	Add password	18
Figure 1-30	Admin settings for date and time	19
Figure 1-31	Setting the clock.....	19
Figure 1-32	Date/time formats	19
Figure 1-33	Mode access button.....	20
Figure 1-34	Mode status.....	20
Figure 1-35	Front panel buttons	20
Figure 1-36	Default settings	20
Figure 1-37	Tip load mode - manual	21
Figure 1-38	Tip load sensor off	21
2 Basic Operation		
Figure 2-1	Home screen on tablet.....	22
Figure 2-2	Help screens.....	22
Figure 2-3	Tip basket (A) and spacer block (B)	23
Figure 2-4	Tip load sequence.....	23
Figure 2-5	Setting the volume.....	24
Figure 2-6	Setting the volume with arrow keys	24
Figure 2-7	SBS-footprint sample reservoirs	25
Figure 2-8	Screen depicting aspirated volume in tip	25
Figure 2-9	Screen depicting dispense volume in tip.....	26
Figure 2-10	Tip eject sequence.....	27
Figure 2-11	384-well plate adapter	27
3 Advanced Operation		
Figure 3-1	Advanced mode and help screen.....	28
Figure 3-2	Options screen.....	29
Figure 3-3	Setting one fixed volume.....	29
Figure 3-4	Setting a sequence of fixed volumes	30
Figure 3-5	Selecting next fixed volume	30
Figure 3-6	Setting the last volume in a sequence	30
Figure 3-7	Selecting next volume in a sequence	31
Figure 3-8	Setting mix volume and number of mix cycles	31
Figure 3-9	Mix parameters set.....	31
Figure 3-10	Independent speed settings.....	32
Figure 3-11	Resetting cycle counter	32
Figure 3-12	Cycle counter reset to zero	32
Figure 3-13	Mode presets	33
Figure 3-14	New preset	33
Figure 3-15	Preset options.....	34

Figure 3-16	Loaded preset.....	34
Figure 3-17	Multi-dispense mode and help screen.....	35
Figure 3-18	Multi-dispense options screen.....	35
Figure 3-19	Setting one fixed volume.....	36
Figure 3-20	Setting a sequence of fixed volumes.....	36
Figure 3-21	Selecting next fixed volume in a series.....	36
Figure 3-22	Setting the last volume in a sequence.....	37
Figure 3-23	Sequence volumes equal to or less than aspiration volume.....	37
Figure 3-24	Setting the last volume in a sequence.....	38
Figure 3-25	Sequential volumes greater than aspiration volume.....	38
Figure 3-26	Aspiration volume sequence.....	38
Figure 3-27	Dilute mode and help screen.....	39
Figure 3-28	Basic dilution.....	39
Figure 3-29	Dilute mode options.....	40
Figure 3-30	Setting the last volume in a sequence.....	40
Figure 3-31	Sequential volumes in Dilute mode.....	40
Figure 3-32	Setting mix volume and number of mix cycles.....	41
Figure 3-33	Mixing in Dilute mode.....	41
Figure 3-34	Reverse pipetting paused after selected volume dispensed.....	42
Figure 3-35	Reverse mode options.....	42
Figure 3-36	Setting one fixed volume.....	43
Figure 3-37	Setting a sequence of fixed volumes.....	43
Figure 3-38	Selecting next fixed volume.....	43
Figure 3-39	Setting the last volume in a sequence.....	44
Figure 3-40	Setting next volume in a sequence.....	44
Figure 3-41	Current cycle count.....	44
Figure 3-42	Cycle count reset to 200.....	45
Figure 3-43	Reverse pipetting without "Blowout" option.....	45
A Appendices		
Figure A-1	Transport lock.....	52
Figure A-2	Non-aligned nozzles (exaggerated view).....	53
Figure A-3	Liquid head left stop bracket with stop (A) and magnet (B).....	53
Figure A-4	Rear tray stops (A) and magnets (B).....	54
Figure A-5	Front tray stops (A) and magnets (B).....	55
Figure A-6	Mounting one tip.....	56
Figure A-7	Proper location of tip between the four wells.....	56
Figure A-8	Rear tray stops (A).....	57
Figure A-9	Tip correctly positioned over well P1.....	57
Figure A-10	Tip correctly positioned over well P2.....	58
Figure A-11	Tray removal.....	58
Figure A-12	Admin Settings screen.....	59
Figure A-13	Service Operations screen.....	59
Figure A-14	System Diagnostics screen.....	60

Section 1 – Safety, Introduction and Set Up

1.1 Safety

Read all safety warnings before installing, making connections or servicing the instrument. Always operate BenchSmart 96 in accordance with these Operating Instructions and keep the instructions close to the instrument for future reference.

Safety notes are marked with signal words and warning symbols. These show safety issues and warnings. Ignoring the safety notes may lead to personal injury, damage to the instrument including malfunction, as well as unreliable results.

1.1.1 Safety terms used in this manual

WARNING – a hazardous situation with medium to high risk, possibly resulting in severe personal injuries (or death) if not avoided, as well as damage to the instrument or laboratory.

CAUTION – a hazardous situation with lower risk, possibly resulting in damage to the instrument and laboratory, in data loss, or minor or medium personal injuries if not avoided.

Attention or Note (no symbol) – for useful or important information about the product.

1.1.2 Symbols used in this manual



General Hazard



Electrical Hazard



Hand Injury Hazard



Explosion Hazard

1.2 Product Specific Safety Precautions

1.2.1 Electrical

WARNINGS



To reduce the risk of electric shock, use only the supplied power cord at the rated line voltage when connecting the BenchSmart 96 to your electrical power supply. Do not modify the power cord in any way or plug it in to an ungrounded power outlet.

To reduce the risk of electric shock, do not remove the cover. No user serviceable parts are inside. Refer to qualified service personnel if help is required.

Use this product only as described in this manual. If the equipment is used in a manner not specified by the manufacturer, the protection provided by the equipment may be impaired.

Do not open the instrument enclosure. There are no user serviceable parts inside.

Danger of explosion if lithium tablet battery is incorrectly replaced. Contact technical support at Rainin or METTLER TOLEDO for correct battery replacement. Dispose of batteries properly.

1.2.2 FCC Statement

The BenchSmart 96 instrument is a Class A device as defined by FCC Title 47, Part 15, Sub-class B. This device complies with part 15 of FCC Rules. Operation is subject to the following two conditions. (1) This device may not cause harmful interference, and (2) this device must accept any interference received, including interference that may cause undesired operation.

See **Section 5 - Specifications** for information on electrical power rating specifications and power cord selection.

1.2.3 General Safety

WARNINGS



Use proper lifting procedures and get assistance for lifting; the instrument weighs approximately 26 kg (57 lbs) and proper lifting procedures should be used.

Keep the front head cavity cover of the instrument closed when the pipette head is moving. Keep hands away from the pipette head (except when changing heads).

CAUTIONS



Always use safe laboratory practices when using BenchSmart 96. Do not work directly under the pipette head. Move the head left or right for clear access to the space required.

Each pipette head weighs approximately 2.5 kg. Be careful not to drop the head when installing or removing.

Never move Benchmark 96 without first locking the liquid head so that it cannot move left or right – see manual for details.

Pipetting strong acids, bases or other aggressive liquids may damage seals, nozzles, or other parts of BenchSmart 96. Clean up any contamination or accidental splashes immediately.

1.3 Introduction

Congratulations on your purchase of the Rainin BenchSmart 96 from METTLER TOLEDO.

BenchSmart 96 is a semi-automated 96/384-well pipettor supplied with one of three quickly interchangeable pipette heads for use in these volume ranges: 0.5-20 μL , 5-200 μL and 100-1000 μL .

The supplied touch-screen tablet controls the motor-actuated pipette heads for aspiration, dispense, tip insertion and ejection. Manual control of the pipettes head's up, down, left and right movements and of the plate trays' forward and back movements give the operator very precise control of the pipetting process.

All settings, user preferences, operational modes and options are controlled via the tablet, which can be mounted on the arm on either side of the instrument. For convenience, aspiration, dispensing, tip loading and ejection can also be controlled via the four programmable buttons on the front panel. A small display on the front panel shows control panel status.

The patented LTS™ LiteTouch™ tip system features perfect sealing on all 96 nozzles and at the same time reduces nozzle wear and tear. LTS prevents tips from jamming or falling off the nozzles, resulting in less downtime and loss of productivity.

BenchSmart 96 is intended for research purposes only. If used for other purposes METTLER TOLEDO is not liable for any resulting damage.

Please read though these Operating Instructions carefully, especially regarding safety, set-up and basic operation, before using the device in real lab conditions. It is the responsibility of the user to read the instructions and to work in accordance with standard operating procedures and general safety guidelines set up for the particular workplace.

1.4 Unpacking and set up

BenchSmart 96 is shipped with a power cord for your location. Before starting to unpack, prepare a clear workspace on your benchtop. BenchSmart 96 weighs about 26 kg (57 lbs) and is 65 cm (24") high, requiring a working horizontal bench space about 1 meter (3'3") wide and 40 cm (1'4") deep.

1.4.1 Check the shipping crate

BenchSmart 96 was shipped from the manufacturer in brand-new condition in one large shipping crate. Check the shipping crate for signs of damage. Damage in transit is the responsibility of the shipping line, not the manufacturer. If there is damage to the shipping crate or contents file a claim with the shipping line. Keep all packaging material if you file a claim.

1.4.2 Unpacking the shipping crate

The contents of the shipping crate are listed and shown in the diagram following:

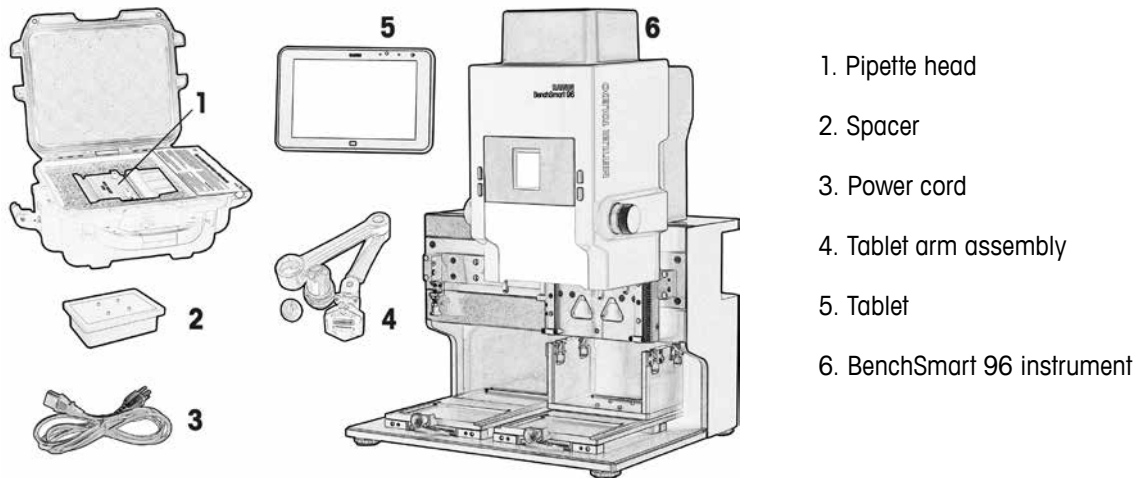

Figure 1-1: Contents of shipping crate

If any items are missing please contact your local METTLER TOLEDO Customer Service or Sales representative. Remove each of the small containers and place on the workspace.



WARNING

Use proper lifting procedures and get assistance for lifting; the instrument weighs approximately 26 kg (57 lbs) and proper lifting procedures should be used.

Carefully lift the BenchSmart 96 instrument from the shipping container and onto the bench. Remove everything from the shipping container. Keep the shipping container: it will be useful if you ever need to transport BenchSmart 96 or return it for authorized service.

1.4.3 Set up, location and placement

Ideally, the workspace should be a clean dry bench area protected from vibration, drafts, away from direct sunlight and near to an electrical power source.

Remove the shipping bracket that protects the instrument during shipping. The bracket is composed of two metal blocks: a top block at the liquid head end and an L-shaped block positioned between the two trays. See Figure 1-2.

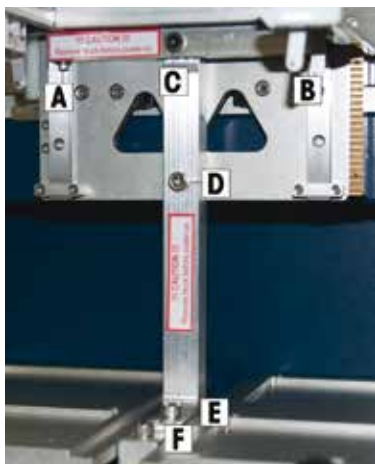

1. Remove the two small screws A and B (hidden in this image) under the top block.
2. Remove the four large screws C, D, E, and F holding the top block and the L-shaped block.
3. Remove both blocks and keep the blocks and all the screws in a safe place for future use.
4. The head is now free to move.
5. For future shipping needs, move the head to the center and reverse these steps to reassemble the brackets.

Figure 1-2: Removing the shipping bracket

Avoid connecting BenchSmart to an electrical source that powers any device with large fluctuations, for example a refrigerator that cycles on and off.

Adjust each of the four adjustable feet as necessary to level the instrument. You can use a hardware store level or an app on your smartphone to help in the levelling process. When level, the liquid head should have free and easy movement left and right along its rail.

1.4.4 Assembling and installing the tablet arm

BenchSmart 96 is controlled via a graphical user interface tablet. This can be mounted on a swing-arm (or using the optional accessory kit, placed on the bench near the instrument).

The swing-arm can be mounted on either side of the instrument. Choose where you want to install the tablet arm: the mounting hardware will fit either side.

The instructions show mounting to the right side as viewed from the front: the left side is similar. Open the tablet arm packet. This contains the parts listed below.



Figure 1-3: Tablet arm components

- 1.4.4.1** Remove the two retaining screws at the back of the unit. Lift off the flat top cover for access to the connector plug (set the cover aside). Locate the arm mounting area on either corner and pull the plastic plug off the fixed mounting screw. See Figure 1-4.

Push the cylinder through the opening and place it loosely over the screw threads with the collar down.

Engage the threads and tighten by turning the cylinder clockwise until it is tight against the bulkhead.

Place the collar over the cylinder and then place the friction ring on top of the collar as shown in Figure 1-5.



Figure 1-4: Fixed mounting screw



Figure 1-5: Partial assembly

- 1.4.4.2** Push the end of the tablet arm through the opening. You may need to rock it back and forth to align the arm connector on the cylinder. See Figure 1-6.

Thread the blue cable through the grommet.

When the arm is correctly in place, push it down as far as the friction ring.

Push the finish cap on top of the cylinder.

Plug in the end of the blue cable at the center of the horizontal plate, as shown in Figure 1-7.

Replace the top cover and replace the retaining screws.



Figure 1-6: Tablet arm installed



Figure 1-7: Cable plug

- 1.4.4.3** At the free end of the arm is a mounting plate that mates with a similar plate on the tablet. See Figure 1-8.

Mounting the tablet is simple. Remove the tablet from its packet and align the bottom of the plate on the tablet with the top of the plate on the arm, then slide the tablet plate down to engage the arm plate.

When properly mounted the two plates will click together. To release the tablet in future, press in the small tab at the top.



Figure 1-8: Arm and tablet mounting plates

1.4.5 Power up the BenchSmart 96 and the tablet



WARNING

To reduce the risk of electric shock, use only the supplied power cord at the rated line voltage when connecting the BenchSmart 96 to your electrical power supply. Do not modify the power cord in any way or plug it in to an ungrounded power outlet.

Refer to Figure 1-9 below and make sure that the BenchSmart 96 power switch near the left rear corner is on the "OFF" position (O) as shown in Figure 1-9A.

Remove the power cord from its package and plug the female end into the power socket. Plug the male end of the cord into a grounded power receptacle.

Press the power switch "ON" (I) as shown in Figure 1-9B.

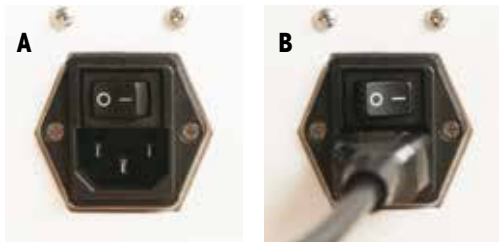

Figure 1-9: Power switch

The BenchSmart 96 will power up and you will see the front panel display as shown (the version will be different than this image).

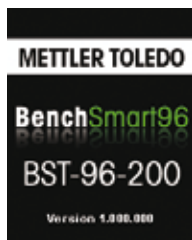
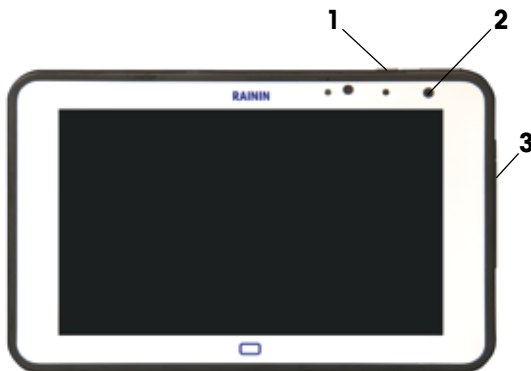

Figure 1-10: Front panel display at power up

Allow 30 minutes for the tablet to charge before you press the power button at the top of the tablet. See Figure 1-11. Only the controls relevant to BenchSmart operation are shown.



- 1** Power button
- 2** Charging indicator LED
 - Off: not connected
 - Orange: connected and charging
 - Green: connected and fully charged
 - Red: charge fault
- 3** USB 2.0 port under pull-off cover (used only for Service Operations – see Appendix A.5)

Figure 1-11: Tablet controls

The BenchSmart application is provided in English as the default, as well as German, French, Spanish, Chinese and Japanese. Set your preferred language as shown below.

1.4.6 Set preferred language

The application default language is English, so if this is your preferred language you can skip to 1.4.7. After switching the tablet on, the **User Login** screen appears, shown in Figure 1-12. Touch the **ADMIN** button and the pipette initialization screen appears, shown in Figure 1-13. Touch **CONTINUE** and wait for the Initialization to complete.

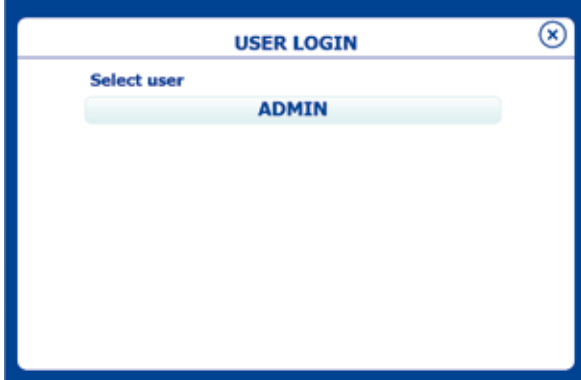

Figure 1-12: User Login screen

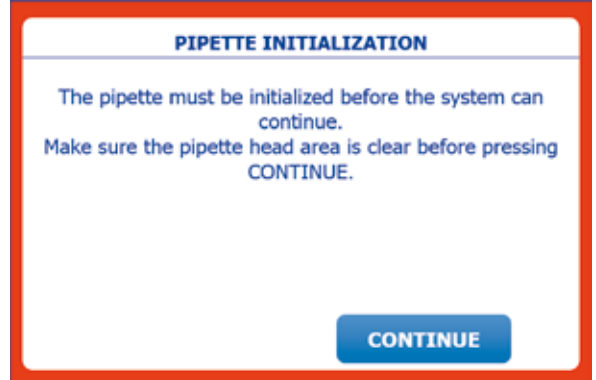

Figure 1-13: Initialization screen

After initialization, the **HEAD LOAD** screen shown in Figure 1-14 will show, and the screen will show the steps in the head load procedure. Touch **CANCEL** to set your language.



Figure 1-14: Head load screen

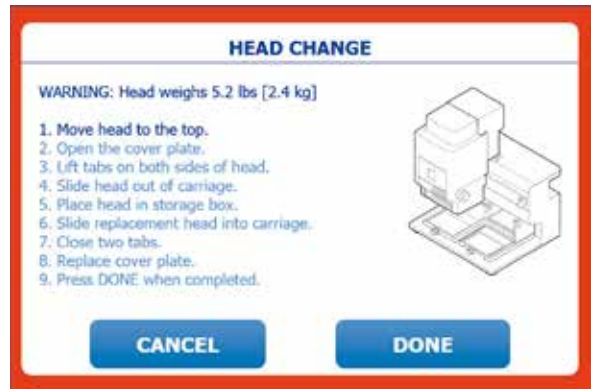

Figure 1-15: Head change screen

After touching **CANCEL** the **Home** screen opens. Touch the Settings icon, Figure 1-16, circled in red. This opens the **Main Setup** screen (Figure 1-17) where you can set your preferred language and other preferences (set up users, administrators and passwords, etc.).



Figure 1-16: Home screen



Figure 1-17: Main setup screen

Touch the **Language** button and then your language. Touch the **DONE** button twice (now in your language) and the interface will be recreated in your language (Figures 1-18 and 1-19).



Figure 1-18: Select language



Figure 1-19: Setup screen in local language

Follow the same logic to adjust any other settings to personalize your BenchSmart 96.

1.4.7 Installing the pipette head

The pipette head can only be installed when BenchSmart 96 and the tablet controller are both connected and powered on. BenchSmart 96 is delivered with one of three pipette heads – 20, 200 or 1000 μ L – supplied in a protective hard case. Check the contents:



1. Pipette head of choice (200 μ L shown)
2. Pipette head support rack
3. Certificate of conformance
4. Head hard case

Figure 1-20: Pipette head components

CAUTION



Each pipette head weighs 2.5 kg (5.2 lbs). Do not drop the head to avoid damage to the nozzles or potential personal injury. An empty tip rack can support the head as shown below.

Note: It is a good idea to use the transport lock (Appendix A1) to secure the liquid head.



Figure 1-21: Using an empty rack to support the pipette head

Press the **Continue** button and follow the instructions on the tablet screen to install the head.

A Move the head to the top of its travel



B Open the cover plate



C Lift the tabs on the head carriage



D Install the new head



E Close the two tabs



F Replace the cover plate

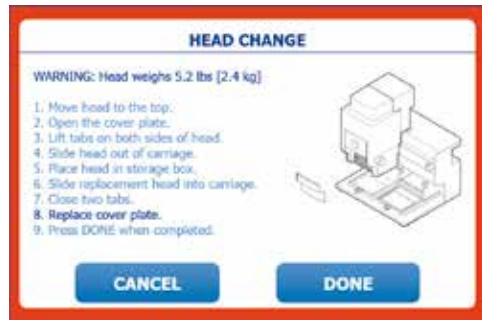

G Touch DONE when finished

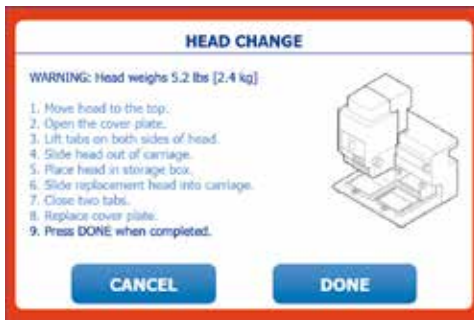

H Initialization screen



Figure 1-22: Head load sequence

Note: This section describes installing a head the first time. Changing a head is similar, but is started by pressing the head change icon on the tablet (circled in red in Figure 1-23).



Figure 1-23: Home screen

BenchSmart 96 is now ready to begin operation. However, we recommend that you familiarize yourself with the user interface before using the instrument for pipetting. The next few pages briefly describe the settings and operational modes.

1.5 Initial operational set up

Navigation and mode selection on BenchSmart 96 is easy and straightforward. The touch-screen allows you to change between the various pipetting modes and options, and also to change the instrument settings to your preferences if you wish. You should already have set your preferred language. Below is an example of other personalized user settings:

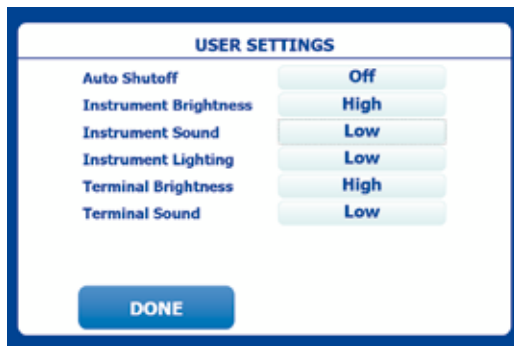

Figure 1-24: User settings

1.5.1 Assigning new users and passwords

Touch the **Admin Settings** button in the **Main Setup** screen and then touch **User Setup**.



Figure 1-25: Admin settings for user setup

Press the **ADD** button to add a new user and assign a password.



Figure 1-26: Add user

Enter the name of the user by touching the keypad as shown below, then touch **DONE**. The new name shows in the list of users.



Figure 1-27: Add user name

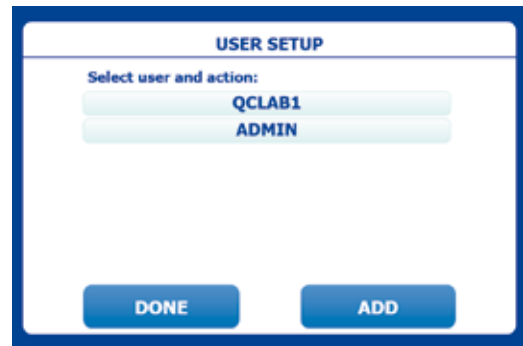

Figure 1-28: Name displayed

To set a password for the new user, touch the name and touch **SET PASSWORD**. Create a memorable password by touching the screen letters then touch **DONE** to save the password for the new user. (User passwords are optional.)



Figure 1-29: Add password

1.5.2 Setting Date and Time

Touch the **Admin Settings** button in the **Main Setup** screen and then touch **Date/Time**.



Figure 1-30: Admin settings for date and time

Check that the tablet clock is set correctly for your local area.



Figure 1-31: Setting the clock

After setting the clock, set the date/time formats.

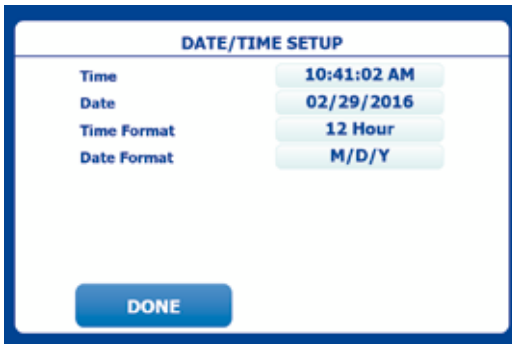

Figure 1-32: Date/time formats

1.5.3 Mode access

To set standard operating procedures or to control experiments, administrators can restrict access to any or all modes for themselves and for other users, either. The **Mode Access** screen allows the user to set access for each mode, selecting between **Unlocked**, **Locked** and **Disabled** for each mode.

Unlocked: Mode settings are editable

Locked: Mode settings are locked and cannot be changed

Disabled: Mode is not visible

In the following example three modes are locked, one is disabled and one is unlocked.



Figure 1-33: Mode Access button

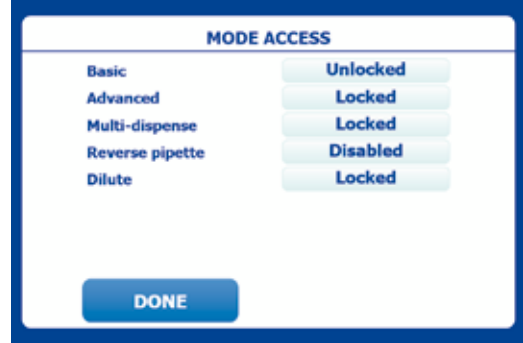

Figure 1-34: Mode status

1.5.4 Setting instrument buttons

For convenience, the functions of the four buttons on the front panel (Figure 1-30) can be switched ON or OFF. When the **Tip Load** and **Tip Eject** controls are set OFF, the front panel tip load and eject buttons are disabled and tip loading and ejection are controlled by the tablet.

Note: If the **Tip Load Sensor** control is set OFF, the tip load procedure will be initiated whenever the top two instrument buttons are pressed or whenever the up arrow is touched in **Tip Load Mode**. See next section.

Button Position / Name

A: Top Left / Aspirate

C: Top Right / Aspirate

B: Bottom Left / Dispense

D: Bottom Right / Dispense

A+C: Both top buttons / Tip Load

B+D: Both bottom buttons / Tip Eject (double press)

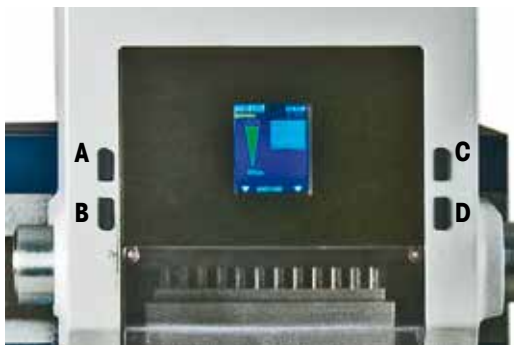

Figure 1-35: Front panel buttons



Figure 1-36: Default settings

1.5.5 Tip Load Sensor and Tip Load Mode

The Tip Load Sensor is a magnetic proximity sensor at the bottom left of the liquid head that allows automatic tip loading while preventing tips to be loaded accidentally. The sensor is triggered by a magnet in the tip basket when the pipette head is lowered onto the basket and will only trigger when the pipette head is correctly positioned on the tip basket,

To begin this exercise, select Tip Load on the Tablet up arrow icon (7a in Figure 2.1) or press the two upper buttons on the front panel simultaneously.

If **Tip Load Sensor** is ON and **Tip Load Mode** is **Automatic**:

Tip loading starts as soon as the liquid head is lowered onto the tip basket

If **Tip Load Sensor** is ON and **Tip Load Mode** is **Manual**:

Tip loading starts after the liquid head is lowered onto the tip basket AND the user presses both aspirate buttons at the same time or touches the up arrow icon on the tablet.

When **Tip Load Sensor** is set to OFF the **Tip Load Mode** is forced to **Manual**:

Tip loading action can be initiated regardless of the liquid head position. In this condition, make sure that the liquid head is in the correct position. See Figure 1-34.

Note: In this condition tip loading initiates when the top two front panel buttons are pressed twice or the up arrow icon is touched, regardless of the tip basket position.



Figure 1-37: Tip Load Mode – manual



Figure 1-38: Tip Load Sensor OFF

Section 2 – Basic Operation

At this point BenchSmart 96 should be on the work bench and powered up, with a pipette head installed and the liquid head free to move in all directions: left, right, up, and down. The tablet should be fixed to the arm and powered up with the BenchSmart application open and the Home screen showing. Home screen elements are listed in Figure 2-1.

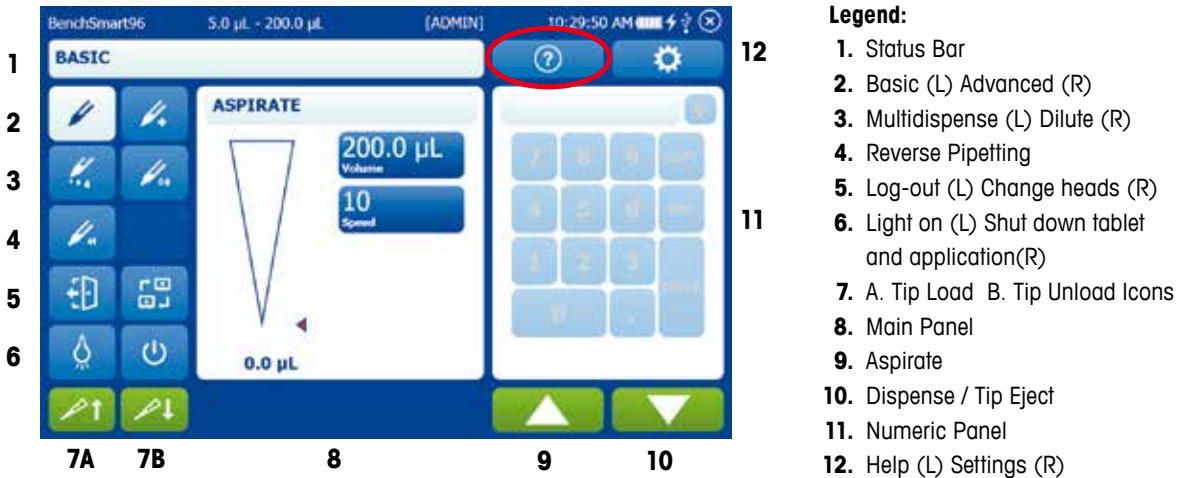

Figure 2-1: Home screen on tablet

Note: The ? (**Help**) button circled in red is a very useful tool. Pressing it in any window where it is available provides overview information about the screen. Below are shown the **Help** screens for **Basic Mode** and **Multi-Dispense Options**. Get used to using this button.

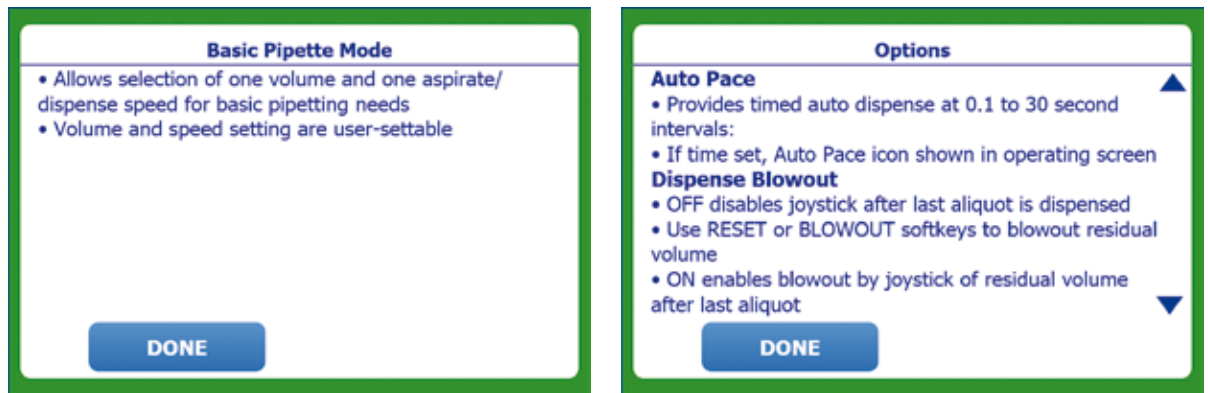

Figure 2-2: Help screens

2.1 Loading tips

This example uses the right position for tip loading: either the right or left side can be used.

To start the tip load procedure make sure you have the appropriate tips ready for the pipette head volume. You will also need the tip basket and, for the 20 µL and 200 µL tip racks, the tip spacer block. For convenience the heads and their support racks are color coded: red – 20 µL, green – 200 µL, blue – 1000 µL.

Tip Load Mode must also be selected by either touching the tablet button (7a above) or pressing the two upper front panel buttons simultaneously.

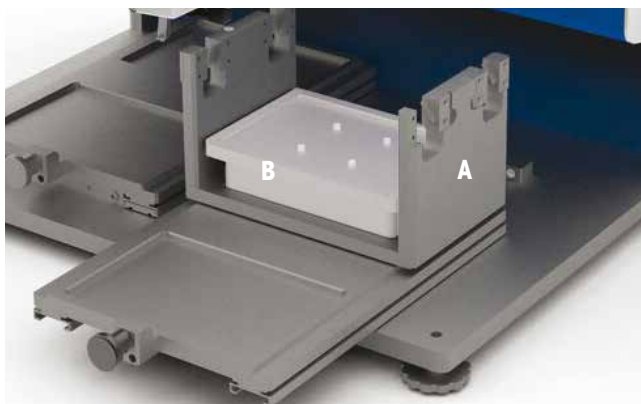

Figure 2-3: Tip basket (A) and tip basket spacer block (B)

Tip loading can be started with the tablet or by pressing both top front panel buttons simultaneously. Tip loading is semi-automated: when the nozzles are positioned correctly in the tips, the clamp mechanism engages the tip basket and pulls the tips up firmly into position.

Make sure the **Tip Load Sensor** control in the instrument button setup screen is set to ON and move the liquid head to the far right position and up to the top of its travel.

If using 20 μL or 200 μL tips, place the tip spacer block on the tip basket. Pull the right tray all the way forward and place the tip basket in position on the rear tray as shown.

Place the full rack of tips (with cover removed) on the tip basket then touch the **Tip Load** icon on the home screen (up arrow) and follow the instructions in the two large panels.

A. Place tip rack on basket (or spacer block)



B. Lower liquid head



C. Contact tips. Tip Basket is pulled upward, loading the tips.



D. Raise liquid head



Figure 2-4: Tip load sequence

Note: if **Tip Load Mode** is set to **Manual** you need to double-press the two top buttons to load tips and there will be an extra step in the process on-screen.

2.2 Aspirating and dispensing

Before pipetting with actual samples, practice aspirating and dispensing into several 96-well plates using water instead of sample.

First set an aspiration volume on the tablet screen. In this example we will use a volume of 100 μL . You will also need to have a 96-well plate that can accept 100 μL in each well.

2.2.1 Setting volume

In the **Home** screen, touch the **Volume** button. It will change from a solid color to an outlined button, and the numeric keypad at right will appear.

To set 100 μL , touch 1 - 0 - 0. The numbers will appear in the value bar at the top as shown in Figure 2-4. Touch **ENTER** to set the volume to 100 μL . Note that BenchSmart will round to the next allowable value: if you enter 101.3 when using a 200 μL head, the value will be rounded to 101.4. Also see the up-down arrow icon circled in red.



Figure 2-5: Setting the volume

Another way to enter is by using the arrow keys. See Figure 2-4.

Touch the up-down arrow icon circled in red to open the quick-set screen.

Touch the double arrows on the small panel to increase or decrease values (by 1 μL for the 0.5-20 μL head, 10 for the 5-200 μL head and 100 for the 100-1000 μL head).

Touch the single arrows at right to make incremental changes.



Figure 2-6: Setting the volume with arrow controls

Aspiration and dispense speeds default to 10 (maximum). For exercise, set the speed to another value in the same way as described above for volume.

2.2.2 Preparing for aspiration

Partially fill a suitable SBS-footprint reservoir with the sample of your choice and place it on the front platform on the tray. Push the tray fully to the back. Place a 96-well plate on one of the front plate platforms on the left-side (or empty) tray.



Figure 2-7: Examples of SBS-footprint sample reservoirs for use with BenchSmart 96

2.2.3 Aspiration

Lower the pipette head until the ends of the tips are immersed into the liquid to approximately the following depths:

Tip size	Immersion depth
20 μL	2-3 mm
200 μL	3-6 mm
1000 μL	6-10 mm

Touch the **Up** arrow on the front panel (or a top button on the front panel of the instrument) and the set volume of liquid will be aspirated into each tip. The tablet display and the instrument display will depict the aspirated volume in the tip as shown in Figure 2-7.



Figure 2-8: Screen depicting aspirated volume in tip

Move the pipette head upward to clear the sample reservoir, then move it fully to the left position for dispensing.

2.2.4 Dispensing

Place the left tray so that the 96-well plate is under the pipette tips, then lower the head so that the ends of the tips are just into the wells.

Touch the **Down** arrow on the panel to dispense 100 μL into each well. The sample will be dispensed and the level shown in the tip image will move downward. At the same time the numeric indicator below the tip will also move to zero.



Figure 2-9: Screen depicting dispense volume in tip

Slowly move the pipette head up so that the tips are just touching the surface of the liquid, so the BenchSmart 96 can complete the blowout step.

Slowly and carefully raise the tips out of the liquid.

2.2.5 Ejecting tips

Attention:

Tips will be ejected immediately on initiation, so be sure that the empty rack is in place.

Tip ejection can be initiated on the tablet or by pressing both bottom front panel buttons. The tips can be ejected with the empty rack in the left or the right-side tray: this example will use the right-side tray.

If using 20 or 200 μL tips, first place the spacer block on the tip basket. Place the tip basket in position on the rear tray and pull the tray all the way forward.

Place the empty rack on the tip basket or on the spacer block and lower the head so that the ends of the tips are aligned with and part way into the openings in the empty rack.

Touch the **Tip Eject** icon on the tablet **Home** screen (or press the lower instrument buttons) and follow the instructions in the two large panels. Touch the **Down** arrow or press the lower instrument buttons and the tips will be ejected into the empty rack.

A Place empty rack on basket



B Lower the head to the tip tray



D Touch the **Tip Eject** button



E Raise the head

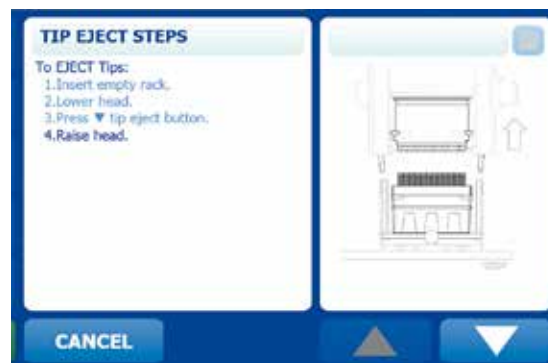

Figure 2-10: Tip eject sequence

2.3 Using the 384-well plate adapter

This optional accessory (17010394 – White, 17010791 – Black) allows BenchSmart 96 to pipette into 384-well plates. The adapter allows a 384-well plate to be moved into four corner positions so that all 384 wells can be filled with four passes of a 96-place tip array.

1. Place the adapter into the working position tray and place the 384-well plate fully right and to the bottom, as shown by the white arrow.



2. Aspirate sample, then move the pipette head over the 384-well plate and dispense into 96 of the wells, as shown here.



Well A1 (top left) is filled

3. Move the 384-well plate fully left and to the bottom then aspirate the next samples. Move the pipette head over the 384-well plate and dispense into the next 96 wells as shown.



Well A2 is filled

4. Move the 384-well plate fully left and to the top, then aspirate the next samples. Move the pipette head over the 384-well plate and dispense into the next 96 wells as shown.

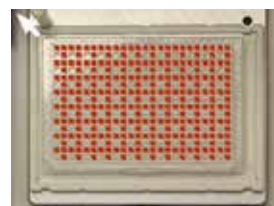

Well B2 is filled

5. Move the 384-well plate fully right and to the top, then aspirate the next samples. Move the pipette head over the 384-well plate and dispense into the remaining 96 wells as shown.

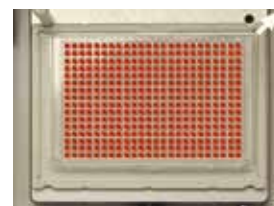





Well B1 is filled

Figure 2-11: 384-well plate adapter

Section 3 – Advanced Operation

Once you are familiar with **Basic** operation, review this section to learn about pipetting modes and options. BenchSmart 96 has four advanced modes: **Advanced**, **Multi-Dispense**, **Dilute** and **Reverse**.

In each of these modes a variety of options are available, shown when you touch the **Help** (?) button (in the image below the **Help** screen is moved to the right for clarity). The **Help** screen is also available for each of the options. When certain options are in use, these icons appear in the right of the main status bar:

Icon	Meaning
	Volume sequencing is set ON. This option is available in the following modes: Advanced , Multi-Dispense , Dilute , Reverse
	Automatic blowout is set OFF. This option is available in the following modes: Advanced , Multi-Dispense , Dilute , Reverse
	Mix is set ON. This option is available in the following modes: Advanced , Dilute
	AutoPace is set ON. This option is available in Multi-Disp mode
	Mode is Locked. (Appears next to mode name)

3.1 Advanced mode

Touch the **Advanced** button to get to this mode. Note that in the **Advanced** screen there are speed settings for both aspiration and dispensing, while **Basic** mode uses one speed setting for both. Touch the ? (**Help**) key to see a brief description of this mode.

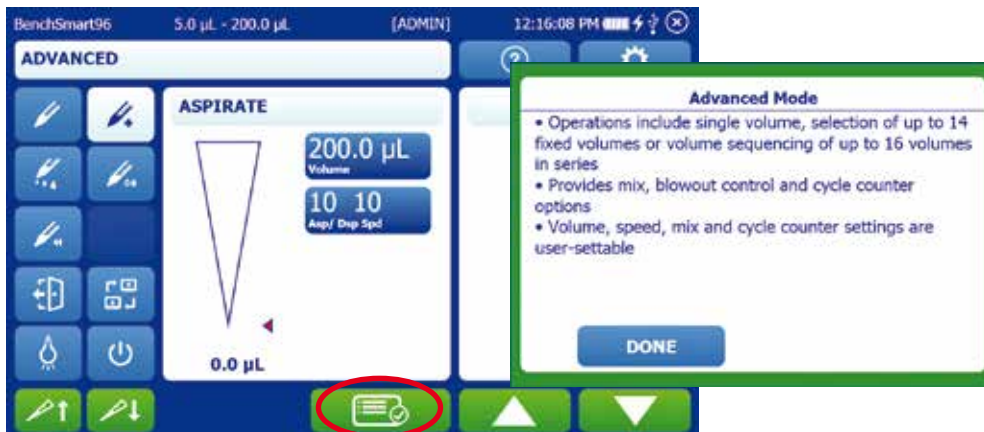

Figure 3-1: Advanced Mode and Help screen

An additional icon in the lower center, the **Options** icon, is circled in red in Figure 3-1. Touching the **Options** icon opens the new screen shown below.



Figure 3-2: Options screen

The options for **Advanced** mode are self-explanatory. The buttons are all “toggle” switches: touching the button changes its state.

- 3.1.1 Fixed volume:** When ON this control allows the user to set a fixed volume and enter this volume into a table. Touch **Fixed Volume** to the ON position, then touch **DONE**.

To see the default fixed volume values, or set them to your own choosing, touch the **Volume** button. The resulting table is pre-populated with 14 values – use these values or set your own following the same logic as setting volumes on page 24.

If you want to use a single fixed volume for your protocol, set it in position 1, then touch the **END VOL** button, as shown in Figure 3-3. Then touch **DONE**.



Figure 3-3: Setting one fixed volume

If your protocol requires stepping through a series of fixed volumes, set the volumes in the order desired, then select the last one in your series as the **END VOL**. Then touch **DONE**.



Figure 3-4: Setting a sequence of fixed volumes

When using a series of fixed volumes, the **NEXT VOL** button cycles through the series. In the example, fixed volume 4 from the above image is selected.



Figure 3-5: Selecting next fixed volume

3.1.2 Volume sequencing: When ON this control allows the user to set a sequence of up to 16 volumes in a table. Volumes are set following the same logic as already seen.

In the **Options** window touch the **Volume Sequencing** button to switch this option ON, then touch **DONE**. To make a sequence of volumes, touch the **Volume** button, then set volumes in the order desired, selecting the last one in your series as the **END VOL**. Then touch **DONE**.



Figure 3-6: Setting the last volume in a sequence

The **NEXT VOL** button cycles through the sequence.



Figure 3-7: Selecting next volume in a sequence

3.1.3 Mixing: BenchSmart 96 allows mixing where a set volume of sample is mixed usually with a second sample.

In the **Options** window touch the **Mix** button to switch it ON. Touch **DONE**. A new **Mix** button appears under the **Speed** button. Touch the **Mix** button to open the control screen.

Set the **Mix Volume** and the number of **Mix Cycles** you require. Then touch **DONE**.



Figure 3-8: Setting mix volume and number of mix cycles



Figure 3-9: Mix parameters set

BenchSmart 96 aspirates 200 μL of the first sample. Then 200 μL will be dispensed into the second sample, and 50 μL of the mixture will be aspirated and dispensed 5 times.

You can set aspiration speed, dispense speed and mix speed independently with **Mixing ON**.



Figure 3-10: Independent speed settings

- 3.1.4 Cycle count:** BenchSmart 96 counts each complete pipetting cycle (aspiration, dispense, blowout) in background. Touch the **Cycle Count** button to switch ON the cycle counter with current use displayed. To reset to zero, touch the button, then enter the new value of 0 as shown in Figure 3-11 and touch **DONE**. The counter will restart at 0 as shown in Figure 3-12.



Figure 3-11: Resetting cycle count



Figure 3-12: Cycle count reset to 0

3.1.5 Blowout: Switching **Blowout** ON adds an automatic step at the end of each dispense cycle to expel the last remnant of sample from the tip for accurate measurements.

Note: After blowout the pipette head automatically resets to home position immediately following the dispense. To prevent this action from partially aspirating the dispensed sample, hold the **Blowout** button while you raise the tips out of the sample, as you would do with a manual or electronic pipette.

If you prefer you can switch **Blowout** OFF, then at the end of the dispense cycle either blowout the remainder of the sample by touching the down arrow, or bypass blowout and aspirate another sample by touching the up arrow.

Manual blowout might be useful if you need to have more touch-off control for your samples, or if you do not wish to blow out automatically at the set time after dispense. In any case it is recommended that some form of blowout be used.

3.1.6 Mode presets: This feature is useful to save sets of commonly-used options. Once you have set your options as desired, touch the **Mode Presets Select** button to start. Then touch **New Preset**, and enter a name with the touch-pad.



Figure 3-13: Mode presets

After touching **DONE**, the new preset name is shown in the list with the current mode settings.



Figure 3-14: New preset

Touch the preset with the name you entered. This opens the **Preset Options** panel where you can **Load**, **Save** or **Delete** the preset.



Figure 3-15: Preset options

Touch **Load**, and the **Home** screen will show with the presets loaded.



Figure 3-16: Loaded preset

If you need to make any changes, set the new parameters (volume, speed, etc.) then touch the **Mode Presets Select** button, open the saved preset then save it again. This will add the changes to the preset.

Setting **Mode Presets** in any mode follows the same logic. **Mode Presets** are unique to each mode – for example, presets made in **Advanced Mode** will not appear in **Dilute Mode**.

Mode Presets are also unique for each head size: for example, **Mode Presets** in **Advanced Mode** on a 5-200 µL pipette head will not appear when using **Advanced Mode** with either a 0.5-20 µL or a 100-1000 µL pipette head.

3.2 Multi-Disp(ense) mode

Multi-Disp mode allows the user to set multiple dispenses from one aspirated volume. Touch the **Multi-Disp** button to get to this mode.

Note that the **Multi-Disp** screen includes two additional buttons: **Aliquot Volume** and (number of) **Aliquots**. Press the ? (**Help**) key to see a brief description of this mode.

In **Multi-Disp** mode BenchSmart 96 aspirates an extra volume of liquid (residual liquid) that is left over after all aliquots have been dispensed, to ensure accurate delivery of all aliquots.

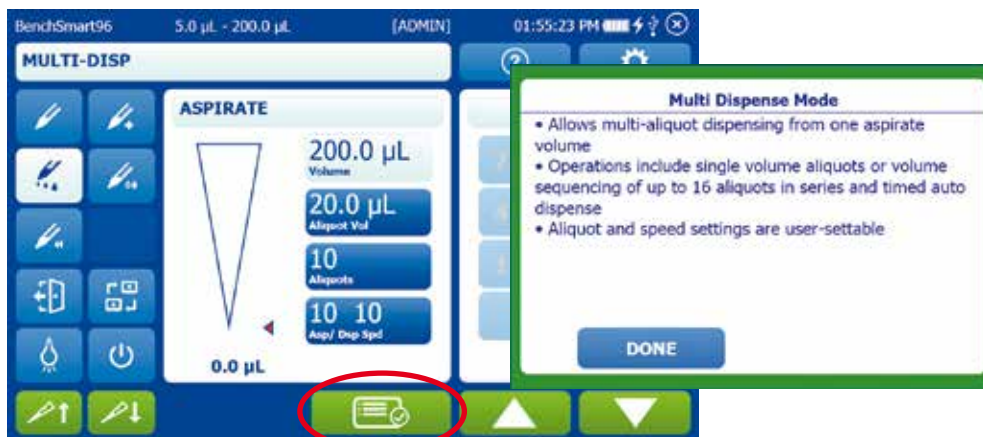

Figure 3-17: Multi-Disp mode and help screen

In **Multi-Disp** mode, setting volume is different to other modes.

The aspirated volume is set indirectly by the number of **Aliquots** together with the **Aliquot Vol**. These settings are linked: BenchSmart 96 will only allow values in the **Aliquots** setting that (with the current **Aliquot Vol**) will not exceed the maximum volume. If the desired value cannot be selected, change **Aliquot Vol** to a lower value. The value will automatically be adjusted based on these two settings.

Touching the **Options** icon (circled in red above) opens the new screen shown below.



Figure 3-18: Multi-Disp options screen

Some of the **Multi-Disp** mode options are already described in the previous section (**Fixed Volume, Volume Sequencing**), but act differently in **Multi-Disp** mode. Other new options (**Auto Pace, Dispense Blowout**) are included, as well as **Mode Presets** (already described).

- 3.2.1 Fixed volume:** When ON this control allows the user to set a fixed aliquot (dispense) volume (up to 14 discrete aliquot volumes can be set in the table). The **Fixed Aliquot** volumes work with the aliquot number to indirectly set the aspiration volume. The feature allows users to conveniently step through their most-used aliquot volumes by touching **NEXT VOL**.

To use a single fixed volume for your protocol in **Multi-Disp** mode, you should set it in position 1, then touch the **END VOL** button, as shown in Figure 3-19. Then touch **DONE**.



Figure 3-19: Setting one fixed volume

If your protocol requires stepping through a series of fixed volumes, set volumes in the order desired, then select the last one in your series as the **END VOL**. Touch **DONE**.



Figure 3-20: Setting a sequence of fixed volumes

Touch **NEXT VOL** to step through the series of fixed volumes.



Figure 3-21: Selecting next fixed volume in series

3.2.2 Volume sequencing: When ON this control allows setting a sequence of up to 16 volumes into a table.

Volume sequencing in **Multi-Disp** mode means **Aliquot Volume** sequencing: after you set the sequence volumes, BenchSmart 96 will calculate the aspiration volume needed to be able to dispense each of the volumes.

In the **Options** window, touch the **Volume Sequencing** button to switch this option ON. Touch **DONE**. To make a sequence of volumes, set the volumes in order as desired, then select the last one in your series as the **END VOL**. Touch **DONE**.



Figure 3-22: Setting the last volume in a sequence

In the example above the four settings in the sequence are equal to the maximum aspiration volume of this model. The resulting screen shows four aliquots and one aspiration volume (one aspiration volume would also be the case when the volumes sequenced add up to less than the maximum aspiration volume).



Figure 3-23: Sequential volumes equal to or less than aspiration volume

However, when the volume of all the sequential dispenses exceeds the maximum aspiration volume, additional aspirations will be calculated and performed in sequence as the aliquot sequence is performed.

In the following example, eight sequential volumes were selected which add up to 900 μL , which is greater than the maximum volume of the instrument, in this case 200 μL .



Figure 3-24: Setting the last volume in a sequence

BenchSmart 96 calculates and displays the number of aspirations and aliquot volumes needed to perform the desired volume sequencing.



Figure 3-25: Sequential volumes greater than aspiration volume

Further into the sequence the changing values are displayed: note that the volume aspirated will change to accommodate the particular aliquot volume in the sequence.



Figure 3-26: Aspiration volume sequence

- 3.2.3 Autopace:** This option is unique to **Multi-Disp** mode. It allows the user to make dispenses automatically at a selected time interval after touching the dispense arrow once. The time interval can be set between 0.2 seconds and 30 seconds, but for practical purposes time intervals of greater than 10 seconds are recommended to allow enough time for the dispense plate to be moved into position or replaced with an empty plate.
- 3.2.4 Blowout:** Switching **Blowout** ON adds an automatic step at the end of each aliquot dispense to expel the last remnant of sample from the tip for accurate measurements.
- 3.2.5 Mode presets:** This feature is useful to save prior settings or if you have a number of BenchSmart 96 users: each user can set and save modes then load them when using the instrument. Touch the **Mode Presets Select** button to start. Touch **New Preset**, then enter a name with the keypad.

3.3 Dilute mode

This mode provides in-tip dilution of multiple sample volumes. Touch the **Dilute** button to get to this mode. Basic dilution (without setting options) aspirates two volumes separated by an air gap by touching the aspirate button 3 times. Then both samples are dispensed together.



Figure 3-27: Dilute mode and help screen

The following screen shows basic dilution: 50 µL of sample A has been aspirated with an air-gap of 10 µL and 20 µL of sample B.



Figure 3-28: Basic dilution

Options for **Dilute** mode: **Volume Sequencing, Mixing, Cycle Count, Blowout, Mode Presets**. Some options are already described but may act differently in **Dilute** mode.



Figure 3-29: Dilute mode options

- 3.3.1 Volume sequencing** in **Dilute** mode allows multiple volumes to be aspirated into the tip, with no air gap between them. In the **Options** window, touch **Volume Sequencing** then **DONE**. To make a sequence of volumes, set the volumes in the desired order, then select the last one in your series as the **END VOL**. Then touch **DONE**.



Figure 3-30: Setting the last volume in a sequence

The screen shows the fourth step from the sequence above, with 120 μL already aspirated.



Figure 3-31: Sequential volumes in Dilute mode

3.3.2 Mix: In **Dilute** mode, both sample and diluent are dispensed into the receiving vessel then a set volume is re-aspirated a set number of times to mix in the tip. Both the mix volume and the number of mixes are set following the same logic as already seen. Mixing can be performed manually or automatically a set number of times.

Note: Manual mixing in **Dilute** mode requires the user to touch and hold the **Down** arrow until the instrument has performed the mix the desired number of times. Automatic mixing in **Dilute** mode requires the user to touch and hold the **Down** arrow until the instrument has started the mix process.

In the **Options** window touch the **Mix** button to switch ON this option. Touch **DONE**. Touch the **Mix** button to open the control screen. Set **Mix Volume** and the number of **Mix Cycles** you require. Then touch **DONE**.



Figure 3-32: Setting mix volume and number of mix cycles



Figure 3-33: Mixing in Dilute mode

In this example BenchSmart 96 has aspirated 100 µL of sample, an air gap, and 75 µL of diluent. When the sample is dispensed into the receiving vessel, 100 µL of the mixture will be mixed five times. The image shows mixing in progress. Manual mixing can be done (if set to manual) by touching the Dispense arrow several times.

3.3.3 Blowout: Switching **Blowout** ON adds an automatic step at the end of each dilute dispense to expel the last remnant of sample from the tip for accurate measurements. Note that **Blowout** ON is necessary in **Dilute Mode** before you can begin aspirating a new sample.

3.3.4 Mode presets: This feature is useful to save prior settings or if you have a number of BenchSmart 96 users: each user can set and save modes then load them when using the instrument. Touch the **Mode Presets Select** button to start. Touch **New Preset**, then enter a name with the keypad.

3.4 Reverse mode

This is an established pipetting technique where the selected volume is aspirated along with the blowout volume, but only the selected volume is dispensed. It is recommended when pipetting volatile or foaming liquids.

When using **Reverse** mode without changing options: the residual volume plus the selected volume is aspirated. Touching the dispense button causes the selected volume to be dispensed, after which the instrument will pause to allow the operator to dispense or blowout the residual volume, as shown in Figure 3-34.



Figure 3-34: Reverse pipetting paused to dispense residual volume

Options for **Reverse** mode are: **Fixed Volume**, **Volume Sequencing**, **Cycle count**, **Blowout**, and **Mode Presets**. Some are already described but may act differently in **Reverse** mode.



Figure 3-35: Reverse Mode options

3.4.1 Fixed volume: When ON this control allows the user to set a fixed volume and enter this volume into a table. The table is pre-populated with 14 values.

To use a single fixed volume for your protocol, set it in position 1, then touch the **END VOL** button, as shown in Figure 3-36. Then touch **DONE**.



Figure 3-36: Setting one fixed volume

If your protocol requires stepping through a series of fixed volumes, set the volumes in order as desired, then select the last one in your series as the **END VOL**. Then touch **DONE**.



Figure 3-37: Setting a sequence of fixed volumes

When using a series of fixed volumes, the **NEXT VOL** button cycles through the series. In the example, fixed volume 3 from the above image is selected.



Figure 3-38: Selecting next fixed volume

3.4.2 Volume sequencing: This control allows the user to set a sequence of up to 16 volumes.

In the **Options** window touch the **Volume Sequencing** button to switch ON this option. Then touch **DONE**. To make a sequence of volumes, touch the **Volume** button then set the volumes in the order desired, selecting the last one in your series as the **END VOL**. Then touch **DONE**. The **NEXT VOL** button cycles through the sequence.



Figure 3-39: Setting the last volume in a sequence



Figure 3-40: Selecting next volume in a sequence

3.4.3 Cycle Count: Touch the **Cycle Count** button to switch it ON and show the current count.



Figure 3-41: Current cycle count

To reset the counter to zero or any other number, touch the counter readout and edit.



Figure 3-42: Cycle count reset to 200

3.4.4 Blowout: Switching **Blowout** ON adds an automatic step at the end of each dispense cycle to expel the last remnant of sample from the tip for accurate measurements.

If you prefer you can switch **Blowout** off, then re-aspiration can occur without a blowout and the screen looks like Figure 3-40, with options for re-aspiration or manual blowout.



Figure 3-43: Reverse pipetting without "Blowout" option

Section 4 – Care and Use

BenchSmart 96 is designed for easy care and trouble-free operation when used in a normal lab setting. Avoid operating the instrument in dusty or damp (condensing) conditions and keep the instrument as clean as possible. As much as possible, prevent liquid spills and splashing: if spills or splashing occur, dry the area as soon as possible.



CAUTION

Avoid aggressive solvents when cleaning the instrument, as the surface may be damaged.

4.1 Cleaning

4.1.1 Tablet and instrument screens, plastic head cover

Clean screens and the plastic head cover with distilled water and a clean cloth. For stubborn or greasy spots, use a mild household detergent applied with a clean cloth.

4.1.2 Outer surfaces

Periodically clean the vertical and horizontal surfaces with distilled water and a clean cloth. To remove any stubborn or greasy spots, use 70% isopropanol or a household detergent applied with a clean cloth.

4.1.3 Plate trays

If spilled sample has dried in or on the plate or lower platform use water or a suitable solvent to dissolve the sample, then remove it with a clean cloth or a soft toothbrush.



CAUTION

Avoid spilling any liquid beneath the plate trays – cleaning spills or dirt from these areas may require tray removal and realignment.

To clean dust or loose debris from beneath the trays, use a commercially-available aerosol blower to blow the dust or debris away.

4.1.4 Lateral rail

The liquid head travels horizontally on a lateral rail; you should keep this area dry and dust-free for smooth operation. Keep liquids away from the top surface of the lateral rail and remove any dust or dirt buildup with a dry soft cloth, soft toothbrush or aerosol blower.

4.2 Maintenance

4.2.1 Routine check

Periodically check all the moving parts for free and clear movement. In all cases movement should be smooth and quiet, and you should never feel any resistance or grinding. Any noise, resistance or grinding will indicate debris or contamination which should be cleaned or removed as soon as possible for accurate and precise performance.

4.2.2 Pipette head lateral movement

If any resistance, stiffness or grinding is felt or heard while the pipette head is moved either left or right, or if the head does not fully reach either end:

- Check to be sure the transport lock is disengaged and lowered. See Appendix A1 for information about the transport lock information. Check for dust or debris on the lateral rail and remove if necessary.
- Check the magnets at each end of the rail for metal debris, like staples or paperclips, and remove if necessary (the magnets help locate the head in its correct position for accurate aspiration and dispensing).

4.2.3 Pipette head vertical movement

For resistance, stiffness or grinding felt or heard while moving the pipette head up or down, either with the control wheel or by two-hand operation, check for debris in the vertical gear teeth and vertical rails. Remove debris if necessary.

4.2.4 Plate tray forward and back movement

For resistance, stiffness or grinding felt or heard while moving the plate trays forward or backward, or if the trays do not reach either the front or back stops:

- Remove any items from the trays and check the movement of both trays – movement should be about the same on both trays. Check for debris on the rail holding the tray in place.
- Check the magnets at both ends of each rail for metal debris, like staples or paperclips, and remove if necessary (the magnets help locate the trays in their correct positions for accurate aspiration and dispensing).

If you need to remove the plate tray to reach and remove debris that may be trapped under the tray, follow the procedure outlined in Appendix A.4.3.

4.3 Troubleshooting

4.3.1 Troubleshooting table

Symptom	Possible Cause	Suggested remedy
Tablet is unresponsive.	Tablet cable is unplugged. Drained battery. Tablet switched off. Instrument is switched off or unplugged.	Ensure both ends of the cable connectors are fully inserted. Ensure tablet is properly seated on the arm. Charge battery - A fully drained battery requires a few minutes to reach a minimum charge before turning on. Ensure the tablet is ON. Ensure the instrument is ON.
Nozzles do not align with plate wells.	Z-axis: Plate tray loose or misaligned. Y-axis: Lateral rail head stops need adjustment. Tip rack or tip rack basket not properly seated in tray pocket.	Align the tray and tighten the screws: see Appendix A.4. Adjust head stops and retighten: see Appendix A.4. Confirm that the rack and rack basket are seated correctly on the tray. Confirm that the tip rack base is fully seated on the deck.
Terminal switches on but does not connect to the instrument.	Loose or disconnected data lead. Instrument power is off. Software error or hardware failure	Check cable connections at both ends of the cable. Confirm instrument power is switched on. In the U.S. call Rainin 800-472-4646, outside the U.S. call local MT office. See mt.com/rainin , "Contact Us" button.
Pipette head will not slide into place.	Head needs to be compressed to fit into the unit	Place the nozzles into an empty tips rack on a stable surface and push down on the pipette head with both hands to compress the head. Install the head again.
Instrument does not auto-launch tip loading. Auto tip load should initiate when the nozzle ends are within 1.5 mm of full insertion inside tips.	Tip rack not properly seated in basket Tip rack sensor out of adjustment or failed. Auto tip load function turned off in software.	Reseat the rack and basket. If sensor not working, enable manual tip load in software tools to bypass the sensor manually by pressing the two upper buttons on the front panel to enable tip load mode and again to initiate tip loading. Ensure that the system is in Tip Load mode. Enable auto tip load in software tools.
Tips load loosely.	Tip eject plate loose on head. Tip rack not seated correctly on tray so one or more clamps miss the basket. Debris under the tip eject plate preventing it from fully retracting.	Reseat the tip rack and reload. Check the basket and basket catch clamps for damage. All four clamps need to grab for even tip loading, If problem persists, inspect/clean the tip eject plate on the head. It comes off with a few screws (use wrench supplied.)
Nozzles do not reach 20 or 200 μ L tips.	No spacer block in place	Use the tip spacer block for 20 and 200 μ L tips.

Symptom	Possible Cause	Suggested remedy
Tips do not aspirate evenly.	<p>Improper sealing of tips on nozzles.</p> <p>Tip not adequately submerged in liquid during aspiration.</p> <p>Seal failure inside head or damaged nozzle.</p>	<p>Ensure correct volume Rainin High-throughput LTS tips are used. Try new tip rack. Check that tips are loaded correctly by the automated tip load procedure.</p> <p>Increase tip immersion during aspiration.</p> <p>Perform a leak test by aspirating at least 50% volume deionized water or buffer. Drips occurring within 2 minutes indicate an internal seal failure. In the U.S. call Rainin 800-472-4646, outside the U.S. call local MT office. See mt.com/rainin, "Contact Us" button.</p>
Dispense volume is not accurate.	<p>Damaged/faulty tips.</p> <p>Leak in the nozzle or tip seal.</p> <p>Aspiration or dispense speed too high.</p> <p>Blowout is OFF.</p>	<p>Try new tips and observe if inaccuracy is repeatable</p> <p>Aspirate full volume, raise the pipette head. Wait for two minutes. If droplets are present after two minutes, call local MT office. See mt.com/rainin, "Contact Us" button.</p> <p>Adjust speeds accordingly</p> <p>Switch Blowout ON. This removes residual liquid in the tips and enhances dispenses more accurately</p>
Liquid head does not reach end of travel at either end.	<p>Left and right stops or magnets need to be adjusted.</p> <p>Metal debris attracted to magnet.</p>	<p>Adjust position of stops and magnets.</p> <p>Remove metal debris from the magnet. See Appendix A.2.</p>
Tray does not travel fully to the front or back position.	<p>Front or back stops need to be adjusted.</p> <p>Metal debris under the tray attracted to magnet.</p>	<p>Adjust stops: see Appendix A.4.</p> <p>Remove tray and clear metal debris from the magnet. See Appendix A.5.</p>
Tray movement is not smooth.	<p>Dirt or debris under the tray.</p> <p>Slide block may be loose.</p>	<p>Remove tray and clean beneath the tray. See Appendix A.5.</p> <p>Remove tray and tighten slide block.</p>
Tips do not fully eject.	<p>Static charge may cause tips to cling to nozzles. The 20 μL tips are very light and can hang on the nozzles.</p>	<p>Release hanging tips by hand.</p>
Arms lock onto the basket during tip eject back into a rack.	<p>Rack basket improperly positioned so clamps cannot swing freely through the rack to release it.</p>	<p>Press and hold the lower right or left button on the front panel to fully extend the basket clamps and manually release the basket.</p>
Cannot operate BenchSmart with tablet.	<p>Lost ADMIN password.</p>	<p>Reset software to factory settings: In the U.S. call Rainin 800-472-4646, outside the U.S. call local MT office. See mt.com/rainin, "Contact Us" button.</p>

Section 5 – Specifications

5.1 Performance specifications

Head size	Low Volume 0.5-20 µL	Mid Volume 5-200 µL	High Volume 100-1000 µL
Channel Accuracy (Systematic Error)	20 µL: ± 1% (0.2 µL) 10 µL: ±1.2% (0.12 µL) 2 µL: ± 6% (0.12 µL) 1 µL: ± 12% (0.12 µL)	200 µL: ±1% (2 µL) 100 µL: ±1% (1 µL) 20 µL: ± 2% (0.4 µL) 5 µL: ± 5% (0.25 µL)	1000 µL: ±1% (10 µL) 500 µL: ±1% (5 µL) 100 µL: ± 2.5% (2.5 µL)
Channel Precision (Random Error)	20 µL: ≤ 0.8% (0.16 µL) 10 µL: ≤1.0% (0.1 µL) 2 µL: ≤5% (0.1 µL) 1 µL: ≤10% (0.12µL)	200 µL: ≤0.4% (0.8 µL) 100 µL: ≤0.8% (0.8 µL) 20 µL: ≤1.5% (0.3 µL) 5 µL: ≤3.5% (0.18 µL)	1000 µL: ≤0.4% (4 µL) 500 µL: ≤0.4% (2 µL) 100 µL: ≤1.25% (1.25 µL)
Volume Increments	0.02 µL	0.2 µL	1 µL

5.2 Electrical specifications

Voltage: 100 - 240 VAC

Current: 2.4 / 1.2 A

Frequency: 50 / 60 Hz

5.3 Electrical considerations

The BenchSmart 96 is powered by a UL/CSA/VDE approved 100-240 VAC, 50/60 Hz input, 45 VDC output power supply. Additionally, the BenchSmart 96 High Voltage circuitry is current-limited to non-hazardous levels. Users should observe the following:



WARNING

Do not open the instrument enclosure. There are no user serviceable parts inside.

The tablet supplied with the BenchSmart 96 uses internal lithium batteries. Batteries should not be incinerated.



WARNING

Danger of explosion if battery is incorrectly replaced. Contact Rainin for replacement.

5.4 Power cord

U.S. and Canada: BenchSmart 96 is shipped with a NEMA 5-15 / IEC 320 power cord. Replacement power cords must be UL Listed, Type SJT or equivalent, minimum No. 18 AWG, 3-conductor with ground conductor that should never be disconnected or defeated. The wall plug must be a three-pin grounding type connector with a NEMA 5-15P (15A, 125V) plug configuration. The cord's connector at the unit must conform to requirements for an EN 60 320/IEC 320 Standard Sheet C13 connector.

Outside the U.S. and Canada: BenchSmart 96 is shipped with a power cord appropriate for shipping location. If a different power cord is required, the cord's plug to the power source must be a three-pin grounding type connector with a plug configuration. The cord's connector at the unit must conform to requirements for an EN 60 320/IEC 320 Standard Sheet C13 connector. The cord's electrical rating must meet or exceed the one originally provided with the instrument. All power cords used with this instrument must be approved by an acceptable, accredited agency responsible for evaluation in the country where the power cord set and system will be used.

5.5 Power malfunction

In case of power malfunction turn off the instrument, unplug it from the power source and contact Rainin technical support in the U.S. or your local METTLER TOLEDO office. NEVER open the instrument cover and do not attempt to troubleshoot the power problem yourself.

Section 6 – Ordering

6.1 Ordering information

Item No.	Description	
BenchSmart 96		
30296705	0.5–20 µL BenchSmart 96, complete	
30296706	5–200 µL BenchSmart 96, complete	
30296707	100–1000 µL BenchSmart 96, complete	
30296708	Pipette head 0.5–20 µL BenchSmart 96	
30296709	Pipette head 5–200 µL BenchSmart 96	
30296780	Pipette head 100–1000 µL BenchSmart 96	
Accessories		
30321288	Feet for use of the tablet on a bench	
30321285	Adjustable height posts	
17010394	384-well adapter plate stage – white	
10710791	384-well adapter plate stage – black	
BioClean Racked Tips for 96-well pipetting		Max Volume
17010645	High-throughput tips, racked	200 µL
17010647	High-throughput tips, racked, sterile	200 µL
17010646	High-throughput tips, filter, racked	200 µL
17011185	High-throughput tips, racked	20 µL
17011186	High-throughput tips, racked, sterile*	20 µL
17011117	High-throughput tips, filter, racked*	20 µL
30281704	High-throughput tips, racked	1000 µL
30296781	High-throughput tips, racked, sterile	1000 µL
30296782	High-throughput tips, filter, racked	1000 µL
30296783	High-throughput tips, racked, sterile, low-retention	1000 µL
30296784	High-throughput tips, racked, sterile, filter, low-retention	1000 µL
BioClean Stacked Tips for 96-well pipetting		
17010648	High-throughput tips, stacked	20 µL
17010649	High-throughput tips, stacked, sterile	20 µL
17011187	High-throughput tips, stacked	200 µL
17011287	High-throughput tips, stacked, sterile	200 µL
Labware		
17012602	Non-sterile low profile 96 pyramidal bottoms, 5-pack	
17012603	Sterile low profile 96 pyramidal bottoms, 5-pack indiv. wrap	
17012604	Non-sterile standard profile 96 pyramidal bottoms, 5-pack	
17012605	Sterile standard profile 96 pyramidal bottoms, 5-pack indiv. wrap	
17012608	Non-sterile low profile 8-channel V-bottom, 5-pack	
17012609	Sterile low profile 8-channel V-bottom, 5-pack indiv. wrap	
17012606	Non-sterile standard profile 8-channel V-bottom, 5-pack	
17012607	Sterile standard profile 8-channel V-bottom, 5-pack indiv. wrap	
17012612	Non-sterile low profile 12-channel V-bottom, 5-pack	
17012613	Sterile low profile 12-channel V-bottom, 5-pack indiv. wrap	
17012610	Non-sterile standard profile 12-channel V-bottom, 5-pack	
17012611	Sterile standard profile 12-channel V-bottom, 5-pack indiv. wrap	
17012623	Non-sterile 2.2 ml 96-deepwell plate, 5-pack	
17012624	Sterile 2.2 ml 96-deepwell plate, indiv. wrap, 5-pack	
17012625	Non-sterile silicone sealing mat fits 96-deepwell plate, 5-pack	
17012626	Sterile silicone sealing mat fits 96-deepwell plate, 5-pack indiv. wrap	
17012627	Non-sterile 1.2 ml racked microtube strips (8x12), 5-pack	
17012628	Sterile 1.2 ml racked microtube strips (8x12), 5-pack	
17012629	Non-sterile microtube strip caps (8), Box of 300	
17012630	Sterile microtube strip caps (8) 25 bags of 12 strips	
17012767	Aluminum 96-well PCR plate holder	

Appendices

A.1 Transport lock

The liquid head transport lock is used when you need to move BenchSmart from one location to another, for example to another bench, lab or location. It is not meant to secure the liquid head during shipping. Use the shipping brackets when shipping the instrument. Removal and replacement of the shipping brackets is described in Section 1.4.3.



CAUTION

Lock the liquid head before moving the instrument to avoid potential injury or damage to the instrument.

The transport lock is located at the left rear of the instrument as shown in Figure A1 below. To lock the liquid head in position for transport:

- Ensure the transport lock knob is fully down. If it is not down, twist it 1/4 turn clockwise as you pull downward. See Figure A-1A.
- Move the liquid head fully to the left – see Figure A-1B.
- Twist the transport lock knob 1/4 turn counterclockwise and the knob will snap up, engaging the liquid head connector.
- To release the liquid head simply pull the transport lock knob downward and twist 1/4 turn clockwise. The knob will stay in the down position and the liquid head will have free and clear travel.



Figure A-1: Transport lock

A.2 Liquid head left and right stops

The right and left stops on the rail for the liquid head provide a precise location so that the nozzles align with the tips for best accuracy and precision. Shock absorbers built into the liquid head prevent the head from jolting the frame if it is quickly pushed to its full travel.

Additionally, a magnet next to each stop helps locate and hold the liquid head in the correct position. The positions of both the stop and the magnet are user-adjustable.

The instrument leaves the factory calibrated with all stops and magnets set in the correct locations. After extended use and normal wear and tear either the stop or the magnet may need to be adjusted.

Pull the left tray fully forward and place a fresh rack of BenchSmart tips into the tip basket on the rear plate. Carefully lower the pipette head until the nozzles almost engage the tips.

Then, viewing from the front, check the left-right position of the nozzles in relation to the tips. The nozzles should be centered directly over the tips. Here is an exaggerated view of non-aligned nozzles:



Figure A-2: Non-aligned nozzles (exaggerated view)

If nozzles and tips are not correctly centered left and right, then the left head stop needs to be adjusted. Use the supplied toolkit for these adjustments.

A.2.1 Adjusting the stop

This procedure describes the left side. Adjusting the right side is virtually identical.

Figure A-3 shows the left stop bracket. Both sides are shown so the the adjustment screws and the stop and magnet can be depicted. The right side version is similar.



Figure A-3: Liquid head left stop bracket with stop A and magnet B

To adjust the left head stop:

- Use the large hex driver and turn the large screw A connected to the stop: clockwise to move the stop inward and counterclockwise to move the stop outward.
- As you adjust the left stop position, check to see if the nozzles align with the tips. Continue adjusting until the tips are aligned in the left-right plane.
- Move the head to the right and the tip basket to the right plate and repeat the above steps to position the right stop.

A.2.2 Adjusting the magnet

The magnet next to each stop helps locate and hold the liquid head in the correct position. If the head does not move away from the end position by itself, the magnet is in the correct position. However, if the liquid head tends to move away from the end of the rail, the magnet may need adjusting. This procedure describes the left side. Adjusting the right side is virtually identical.

To adjust the left magnet, use the small hex driver and turn the small screw B connected to the magnet: clockwise to move the magnet inward and counterclockwise to move it outward.

- As you adjust the left magnet position, check whether the liquid head tends to move away from the end position by itself. Continue adjusting until the liquid head stays in position, but do not adjust the magnet too far: it works by proximity, not contact.
- Move the liquid head to the right and repeat the above steps to position the right magnet.

A.3 Rear and front tray stops for tip mounting alignment

A.3.1 Setting the tray rear stops

This procedure describes the right side trays. Adjusting the left side is virtually identical.

- Move the liquid head fully to the right until you reach the right stop.
- Place the rack of tips into the front plate and push the right-side tray fully back.
- Slowly lower the pipette head until the nozzles almost engage the tips, then, viewing from the side, check the forward-backward position of the nozzles in relation to the tips. They should be centered directly over the tips.

If they are not fully centered forward and backward, then the right rear tray stop screws need to be adjusted.

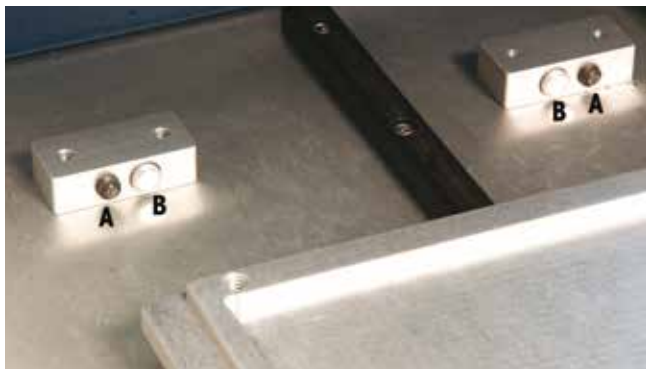

Figure A-4: Rear tray stops (A) and magnets (B)

- To adjust the rear stops, using the large hex driver turn the large screws A connected to the stop: clockwise moves the stop inward, counterclockwise moves the stop outward.
- Make very small adjustments to the positions of the rear stop while you check that nozzles align with the tips. Continue adjusting until the tips are aligned in the front-back plane. After adjusting the magnet (see next paragraph) move the tip rack to the left side and repeat for adjusting the left rear tray stops.

A.3.2 Adjusting the tray rear magnet

Magnets next to each stop help locate and hold the tray in the correct position. If you can feel the magnetic assist at the end of the tray stop travel, the magnet is in the correct position. However, if the tray is free to move without any magnet feel, or if it sticks at the end of travel, the magnets may need adjusting. This procedure describes adjusting the right side; adjusting the left side is virtually identical.

Figure A-7 shows the left tray rear stop brackets with the stops (A) and magnets (B) shown.

Note that the magnets (B) are closer to the center.

- To adjust the magnets, use the small hex driver and turn the small screws B connected to the magnets: clockwise moves the magnet inward and counterclockwise outward.
- As you adjust the magnet positions, check to see that the magnet attracts and helps locate the tray at the end of travel. Continue adjusting until the magnet is in the correct position, but do not adjust the magnets too far: they work by proximity, not contact.
- Move the head to the left and after setting the rear stop, repeat these steps to position the left rear magnets.

A.3.3 Setting the tray front stops

This procedure describes the left side trays. Adjusting the right side is virtually identical.

- Move the liquid head fully to the left until you reach the left stop.
- Place the rack of tips into the rear plate and pull the left-side tray fully forward.
- Slowly lower the pipette head until the nozzles almost engage the tips, then, viewing from the side, check the forward-backward position of the nozzles in relation to the tips. They should be centered directly over the tips.

If they are not fully centered forward and backward, then the left front tray stop screws need to be adjusted.



Figure A-5: Front tray stops (A) and magnets (B)

To adjust the front stops, use the large hex driver and turn the large screws A connected to the stop: clockwise moves the stop inward and counterclockwise moves the stop outward.

Make very small adjustments to the positions of the front stop while you check that the nozzles align with the tips. Continue adjusting until the tips are aligned in the front-back plane. After adjusting the magnets (see next paragraph) move the tip rack to the right side and repeat for adjusting the right front tray stops.

A.3.4 Adjusting the tray front magnet

Magnets next to each stop help locate and hold the tray in the correct position. If you can feel the magnetic assist at the end of the tray stop travel, the magnet is in the correct position. However, if the tray moves freely, or if it sticks at the end of travel, the magnets may need adjusting. This procedure describes adjusting the right side; adjusting the left side is virtually identical.

Figure A-5 shows the left tray front stop brackets with the stops (A) and magnets (B) shown. Note that the magnets (B) are closer to the center.

- To adjust the magnets, use the small hex driver and turn the small screws B connected to the magnets: clockwise moves the magnet inward and counterclockwise outward.
- As you adjust the magnet positions, check to see that the pull of the magnet and helps locate the tray at the end of travel. Continue adjusting until the magnet is in the correct position, but do not over-adjust the magnets: the magnets work by proximity, not contact.
- Move the liquid head to the right and after setting the right front stop, repeat these steps to position the right front magnets.

A.4 Rear and front tray stops for 384-well plates

Use this procedure to accurately align the trays so that the tips locate the 384 wells in each of the 384-well plate adapter's four positions.

The example will show the procedure for the right trays and will use only one tip for clarity: the procedure is similar for the left trays.

A.4.1 Checking the rear stop

Move the liquid head fully to the right until you reach the right stop.

- Place a 384-well tray onto the front right tray without the plate adapter. Push the tray all the way back until it hits the rear stop.
- Mount one tip to the nozzle at the left front corner of the pipette head as shown below.



Figure A-6: Mounting one tip

- Lower the pipette head to see where the tip makes contact with the 384-well plate. It should touch the plate centrally in the space between the four wells at the left front corner, wells P1, P2, O1 and O2, as shown in Figure A-7.



Figure A-7: Proper location of tip between the four wells in the left corner of the plate

If the tip is correctly in this position, the tray is correctly aligned and you do not need to make any adjustments to the right tray.

If the tip end is offset to the left or right, you will need to go back and re-adjust the left and right stops as outlined in Appendix A.2 (this step should not be necessary unless the adjustment was not done correctly).

If the tip end is offset to the front or back, you will need to adjust the rear stop.

A.4.2 Adjusting the rear stop

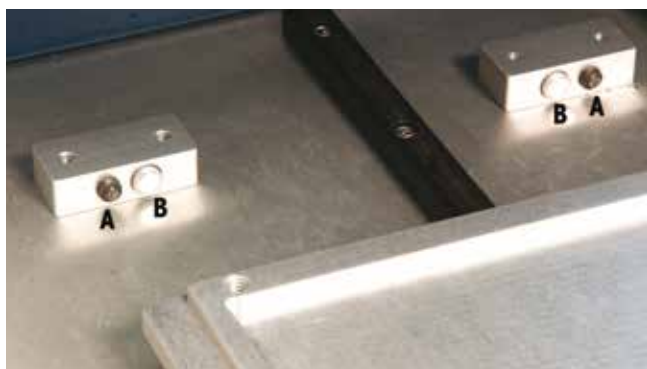

Figure A-8: Rear tray stops (A)

- Push the right tray back until it reaches the stop.
- Remove the 384-well plate and put the 384-well plate adapter into the tray. Then place the 384-well plate onto the adapter.
- Push the 384-well plate into the top right corner of the adapter and bring the pipette head down until the tip reaches the plate.
- Adjust the rear stop – turning the screw counterclockwise moves the tray back, clockwise moves it forward – until the tip fits over the center of well P1, as shown in Figure A-9.

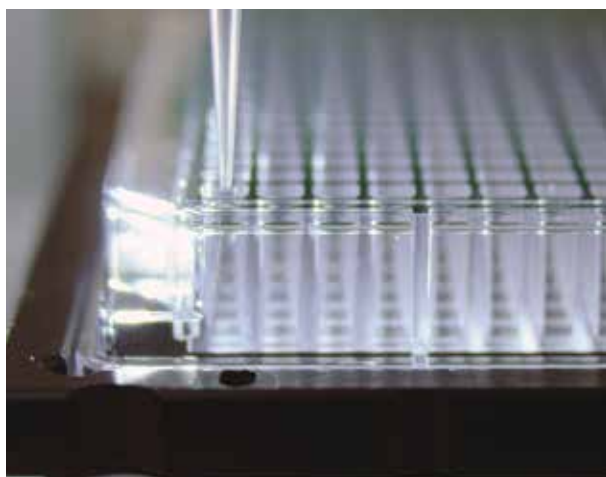

Figure A-9: Tip correctly positioned over well P1

Once the tip is correctly centered in well P1, all tips will fit their wells properly: at this point the rear stop is adjusted correctly and should be left alone.

For a quick check you can move the 384-well plate to the top left position, bring the pipette head slowly down and see that the tip fits properly over well P2, as shown below.

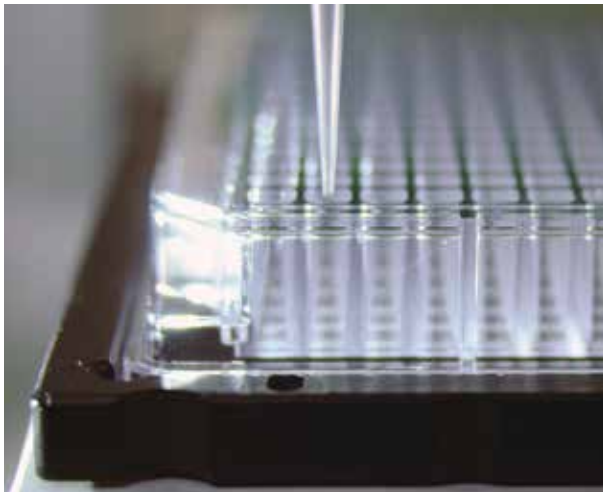

Figure A-10: Tip correctly positioned over well P2

Once the tray is positioned correctly, repeat the above instructions for the front tray, then move the liquid head fully to the left until you reach the left stop and repeat all steps for the left side tray.

A.4.3 Removing the front stop and tray

There may be a need to remove the tray to clear out trapped debris that can impede the smooth motion of the tray. If this is the case, follow this procedure outlined below:

- Remove the two screws at the top of both front stops, marked A in Figure A-11
- Remove the stops, and then remove the tray by sliding it all the way off.

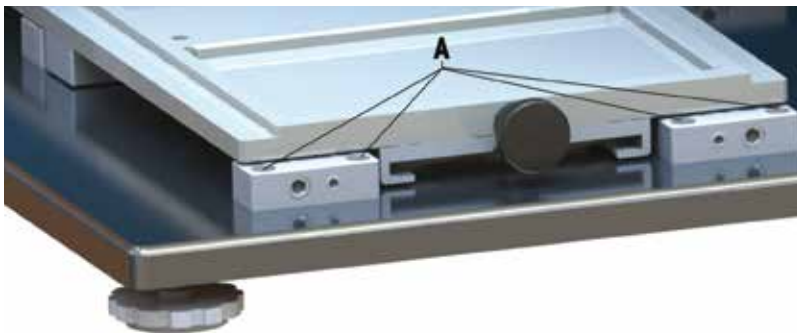

Figure A-11: Tray removal

- Clean any debris from under the tray. You will not need to remove the slider blocks beneath the tray, but you should clean thoroughly around the magnets on the back stops and remove any metal debris.
- Slide the tray back in position.
- Make sure the magnets on the front stops are clear of metal debris, then place the two front stops in position and tighten the mounting screws.

A.5 Service operations

To open **Service Operations**, first touch the **Settings** icon (#12 in Figure 2-1) to open the settings window. Then, touch the button named **Admin Settings** and the screen shown below will open with the **Service** button at the end of the list.

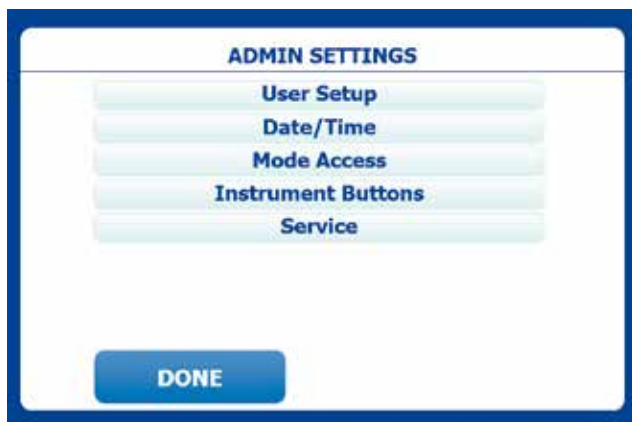

Figure A-12: Admin Settings screen

Touch **Service** to open the **System Operations** screen. Some functions require a USB memory stick – the USB slot is on the right side of the tablet under a cover (#4 in Figure 1-11).



Figure A-13: Service Operations screen

Factory Reset: Warns that system settings will be reset to factory defaults, removing all users, user settings and presets.

Backup Terminal Settings: Advises to insert a USB memory stick on which to save your settings.

Restore Terminal Setting: Advises to insert the previously-used USB memory stick containing the backup settings.

Upgrade Terminal Software: Advises to insert a USB memory stick containing the software upgrade package.

Upgrade Terminal Firmware: Advises to insert a USB memory stick containing the firmware upgrade package.

Note: **System Diagnostics** are included with this manual so that in the event of a technical problem, you will be able to give more information to the Rainin or METTLER TOLEDO Technical Support group. Otherwise you should not need to go to this area of the application.

System Diagnostics: Opens the System Diagnostics screen.

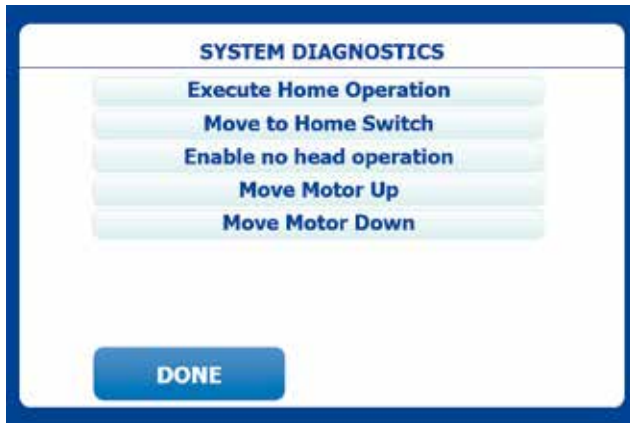

Figure A-14: System Diagnostics screen

Execute Home Position: Moves the pistons to the appropriate home position for the current pipetting head.

Move to Home Switch: Moves the pistons and piston plate to a position where the home switch is closed. The switch is the “home” reference point for all motor positions. This function is mainly used by service to adjust the home switch mechanically.

Enable No Head Operation: Allows operation of the mode menus on the main screen when no head is inserted, otherwise the mode buttons are disabled and only head load, logout, shutdown, and lights operate. This setting resets to “Disable” when the Admin logs out.

Move Motor Up: Move the motor (and pipetting head) up a small number of steps

Move Motor Down: Move the motor (and pipetting head) down a small number of steps.

Note: After any move, the system homes the motor when the service menu is exited.



Declaration of Conformity

Manufacturer's Name: Mettler-Toledo Rainin, LLC
Manufacturer's Address: 7500 Edgewater Drive, Oakland, CA, 94621, USA

Declares that the following product:

Product Name BenchSmart 96 Plate Pipetting Device
Model Number: BST-96-20, BST-96-200, BST-96-1000

Conforms to the following EC directives (including all applicable amendments):

2014/35/EU Low voltage (LVD)
2014/30/EU Electromagnetic compatibility (EMC)

Supplementary Information:

Applied Standards:
Safety: IEC/EN 61010-1:2010
Emissions Testing: EN 61326-1:2013
EN 55011:2009 A1:2010 (Class A Group 1)
Testing performed to: Class A Limits (commercial/industrial environment)
Immunity Testing: EN 61326-1:2013
EN61000-4-2 Electrostatic Discharge
EN61000-4-3 Radiated Immunity
EN61000-4-4 Electrical Fast Transients
EN61000-4-5 Surge: Power Ports
EN61000-4-6 Conducted Immunity
EN61000-4-11 Voltage Dips and Interrupts

I, the undersigned, hereby declare that the equipment specified above conforms to the above Directives and Standards.

Responsible Signatory: Deryl Stanley, Head of R&D

Year First Applied: May, 2016

This Declaration of Conformity applies only to products which have the CE mark attached.

This device complies with all CE rules and requirements.

Disposal



The tablet contains a CE-compliant battery pack.

In conformance with the European Directive 2012/19/EU on Waste Electrical and Electronic Equipment (WEEE) used tablet batteries may not be disposed of in domestic waste. This also applies to countries outside the EU, per their specific requirements.

Please dispose of used batteries in accordance with local regulations at the collecting point specified for electrical and electronic equipment.

If you have any questions, please contact the responsible authority or the distributor from which you purchased this device.

Should this device be passed on to other parties (for private or professional use), the content of this regulation must also be related.

Thank you for your contribution to environmental protection.

RoHS Regulation # 2011/65/EU:



Rainin and METTLER TOLEDO fulfil requirements under RoHS Regulation # 2011/65/EU.

BenchSmart 96 products and accessories comply with the above mentioned RoHS Regulation as Category 9 products.

www.mt.com/rainin

For more information

Mettler-Toledo Rainin, LLC.

7500 Edgewater Drive
Oakland, CA 94602 USA
Sales +1 510-564-1600
Service +1 510-564-1600

Subject to technical changes

© 2016 Mettler-Toledo Rainin, LLC.

30327387 Rev A - EN Printed in USA